



TOWBARS

2023

TOWBARS CATALOGUE

TOWBARS AND ACCESSORIES

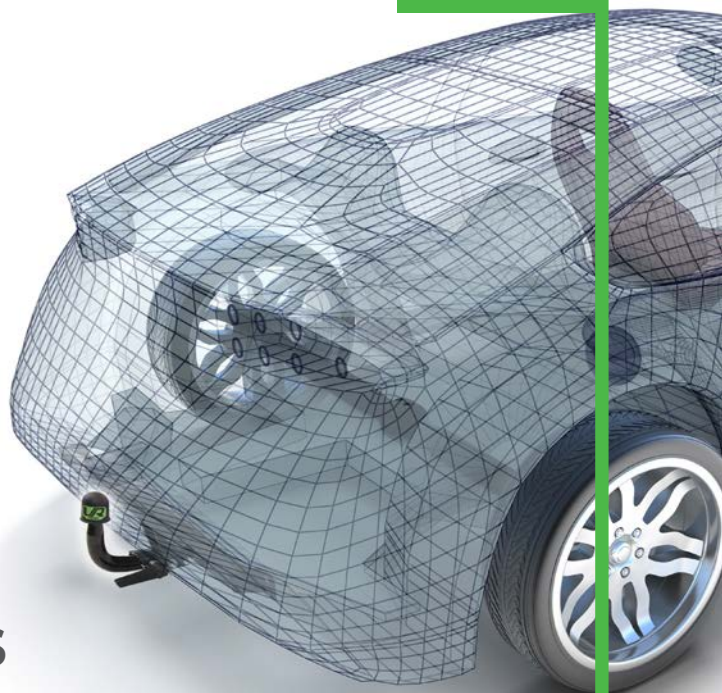

v. 38B 12/04/2023

TOWBARS FOR PASSION



UR **UMBRA RIMORCHI**

www.umbrarimorchi.it



”

**WE LOOK
TO THE FUTURE**

GENERAL INFORMATIONS:

+44 208 144 0509

trade@umbrarimorchi.co.uk

TOWBARS DEPARTMENT:

ufficio.ganci@umbrarimorchi.it

ACCOUNT DEPARTMENT:

amministrazione@umbrarimorchi.it

EXPORT DEPARTMENT:

expo.dpt@umbrarimorchi.it

export@umbrarimorchi.it

INDEX

CERTIFICATIONS	III
OUR SERVICES	IV
UMBRA RIMORCHI IN THE WORLD	V
TOWING DISPOSALS	VI
TOWBARS FOR CAMPERS	VII
MOTORHOME TOWBARS CATALOGUE	IX
OUR WORK	X
OUR STRENGTHS	XI
OUR BESTSELLERS	XII
WIRING KITS	XIII
NEW WIRING KITS 2023	XV
TOWBARS CATALOGUE	1
SPARE PARTS AND TOWBARS ACCESSORIES	70
WIRING KITS AND ELECTRICAL DEVICES	72
GENERAL TERMS OF SALE	XVII

CERTIFICATIONS

GOAL: EXCELLENCE



The certification of our products, as well as the mission of our company, has the sole purpose of offering our customers absolute excellence.

Umbra Rimorchi has held these international certifications since 1997 and is constantly updated to offer the highest quality for the production of its products.



Quality management system complying with the standard for the design and production of tow hooks.



Certificate Quality Management System Design and Manufacture of towbars for cars and spare parts





OUR SERVICES

CONSTANTLY GROWING



QUALITY

Our products are always the best. We are Italian's N. 1 company within the industry.



RELIABILITY

You can always be sure to have the excellence you need. Because we are the best.



CUSTOMER CARE

Our employees are always available to assist you with your enquiries and questions.

UMBRA RIMORCHI EXPANDS

THE BRAND UMBRA RIMORCHI BRAND EXISTS THROUGHOUT EUROPE, NORTH AFRICA, MIDDLE AND EXTREME EAST. WE ARE CREATING NEW PARTNERSHIPS EVERY DAY.

OVER THE LAST YEAR, LOGISTICAL DEPOTS HAVE BEEN SET UP IN THREE DIFFERENT COUNTRIES, WHICH WILL BE JOINED BY ANOTHER THREE IN THE COMING MONTHS.



OVERSEAS DISTRIBUTION IN AUSTRALIA AND SOUTH AMERICA WILL ALSO BEGIN EXTREMELY QUICKLY.



UMBRA RIMORCHI

IN THE WORLD



LEADER IN ITALY

**IN THE PRODUCTION OF TOW HOOKS
WITH WORLDWIDE EXPORTS**

Our company for many years has been the leading Italian manufacturer of towbars for cars and commercial vehicles and can rely on a network of technicians and distributors widespread and deeply well-established throughout the territory.

Today Umbra Rimorchi exports more than 50% of its turnover, registering an increase of over 1600% in the last two years.

Precisely because of the strong expansion abroad it has been created a new independent brand "UR towbars", green in color, which soon began to establish itself in Italy and is now our main product identifier.

UMBRA RIMORCHI HAS ALWAYS BEEN SYNONYMOUS WITH QUALITY AND RELIABILITY. OUR COMPANY ENJOYS THE RESPECT OF CUSTOMERS THANKS TO THE HIGH LEVEL OF SERVICE OFFERED CONSTANTLY OVER TIME.

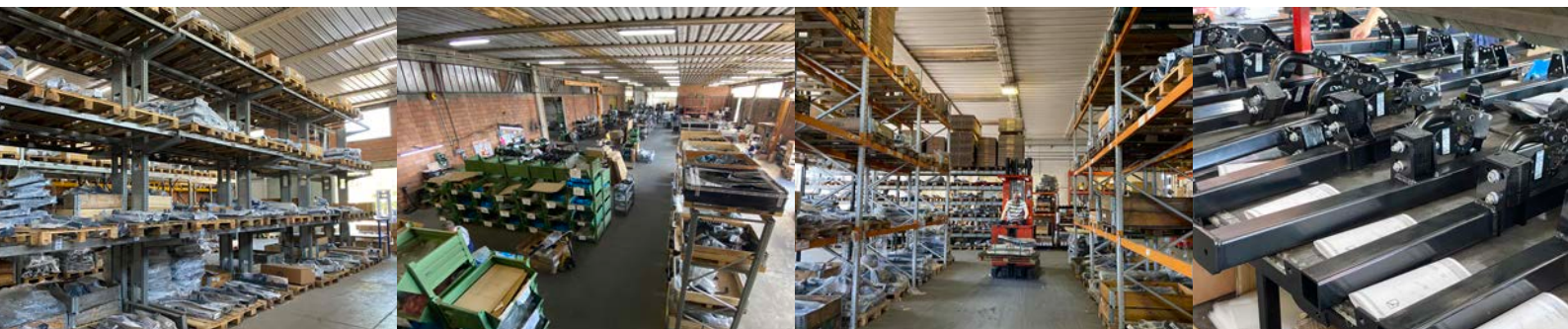

TOWING DISPOSALS

OUR PRODUCTS

These are our best selling products. Umbra Rimorchi has always offered a guarantee of excellence.



MODEL F

Fixed swan neck ball



MODEL C

Manually detachable ball with safety lock



MODEL VM

Vertical detachable ball that disappears completely

FIXED TOWBARS



MODEL DM



MODEL SF



MODEL SF(M)



MODEL GRIFO



MODEL GM

DETACHABLE TOWBARS



MODEL A

manually detachable ball



MODEL M

manually detachable ball with safety lock



MODEL V

vertical detachable ball that disappears completely

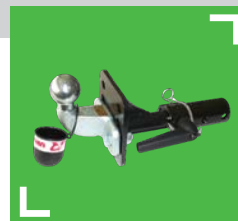

MODEL SF (C)

fixed interchangeable device with ball and hook



MODEL GRIFO (C)

fixed interchangeable device with ball and hook

TOWBARS

FOR CAMPERS

Recently we have included in our production the universal towing beam for campers, as well as a complete series of specific attachments and extensions for each frame.



MODEL F
Fixed swan neck



MODEL C
Manually detachable ball

TODAY WE ARE ABLE TO PROVIDE A TOW HOOK WITH ALMOST ANY CAMPER CIRCULATING ON THE ROAD.





ADVANTAGES

Camper towing hooks are a precious resource, and more and more essential if you want to transport everything you want and everything you need.



EASE OF USE

Practical, handy and simple to assemble.



COMPETITIVE PRICE

In line with customer research and needs.



EU APPROVAL

Further guarantee of extreme quality.

Thanks to our company, the transport of motorbike, parcel or bike carriers will no longer be a problem.

Our selection of tow hooks, attachments and control units is based not only on aesthetic but above all technical criteria. Our tow hooks are characterized by their ease of installation, their high quality and their competitive price, without neglecting the fact that they have European approval according to Directive 94/20 / EC or Regulation R55.

Umbra Rimorchi has always been synonymous with guarantee and reliability: we are specialists in accessories for the transport of campers, combining quality and technical rigor to offer customers truly functional products at competitive prices.

CATALOGUE

MOTORHOME TOWBARS

Complete towbars and hitches catalogue,
including code and description

CODE	DESCRIPTION
186000300011000000	TOWBAR MOTORHOME SLIDING FIXED TOWBALL
186000300021000000	TOWBAR MOTORHOME SLIDING C TOWBALL
186000400001000000	HITCH FIAT DUCATO 250 '06, CITROEN JUMPER Y '06, PEUGEOT BOXER Y '06
186000401001000000	HITCH FIAT DUCATO 280/290 1981-1993
186000402001000000	HITCH FORD TRANSIT FT150 SHORT WHEELBASE UNTIL 2000
186000403001000000	HITCH FORD TRANSIT FT150 LONG WHEELBASE UNTIL 2000
186000404001000000	HITCH FORD TRANSIT FT350 TWIN WHEEL FROM 2000
186000405001000000	HITCH FORD TRANSIT V185 SINGLE WHEEL FROM 2000
186000406001000000	HITCH IVECO DAILY UNTIL 2004
186000407001000000	HITCH FIAT DUCATO,CITROEN JUMPER,PEUGEOT BOXER 230/244 94-06 WITH PLATFORM
186000408001000000	HITCH FIAT DUCATO,CITROEN JUMPER,PEUGEOT BOXER 230/244 94-06 NORMAL
186000409001000000	HITCH RENAULT MASTER '98 -'10, RENAULT MASTER '10
186000410001000000	2 POSITIONS LOWERING KIT AL-KO FRAMES AND MOTOHOME WITH EXISTING EXTENSION BARS
186000411001000000	HITCH MERCEDES SPRINTER, VW CRAFTER 316 SINGLE WHEEL AFTER 2006
186000412001000000	HITCH MERCEDES SPRINTER, VW CRAFTER 316 SINGLE WHEEL UNTIL 2006
186000413001000000	HITCH MERCEDES SPRINTER, VW CRAFTER 416 TWIN WHEEL AFTER 2006
186000414001000000	HITCH MERCEDES SPRINTER, VW CRAFTER 416 TWIN WHEEL UNTIL 2006
186000415001000000	5 POSITIONS LOWERING KIT AL-KO FRAMES AND MOTORHOME WITH EXISTING EXTENSION BARS
186000417001000000	HITCH IVECO DAILY BLACK FRAME UNTIL '06, '06 -'14
186000418001000000	HITCH FORD TRANSIT WITH PLATFORM '14
186000419001000000	HITCH RENAULT MASTER X62 NORMAL '10
186000420001000000	HITCH RENAULT MASTER WITH PLATFORM '10 EXTENSION BARS 550MM
186000421001000000	HITCH RENAULT MASTER WITH PLATFORM '10
186000430001000000	HITCH FIAT DUCATO 250 '06 EXTENSION BARS 2000MM
186000431001000000	HITCH FIAT DUCATO 280/290 1981-1993 EXTENSION BARS 2000MM
186000460001000000	HITCH FIAT DUCATO 250 '06 EXTENSION BARS 1700MM
186000464001000000	HITCH FORD TRANSIT FT350 TWIN WHEEL FROM 2000 EXTENSION BARS 1700MM
186000468001000000	HITCH FIAT DUCATO 230/244 94-06 NORMAL EXTENSION BARS 1700MM
186000477001000000	HITCH IVECO DAILY BLACK FRAME UNTIL '06, '06-'14 EXTENSION BARS 1700MM

D VALUE

14,5 kN

S VALUE

150 Kg

OUR WORK

MODERN DESIGN TECHNOLOGIES

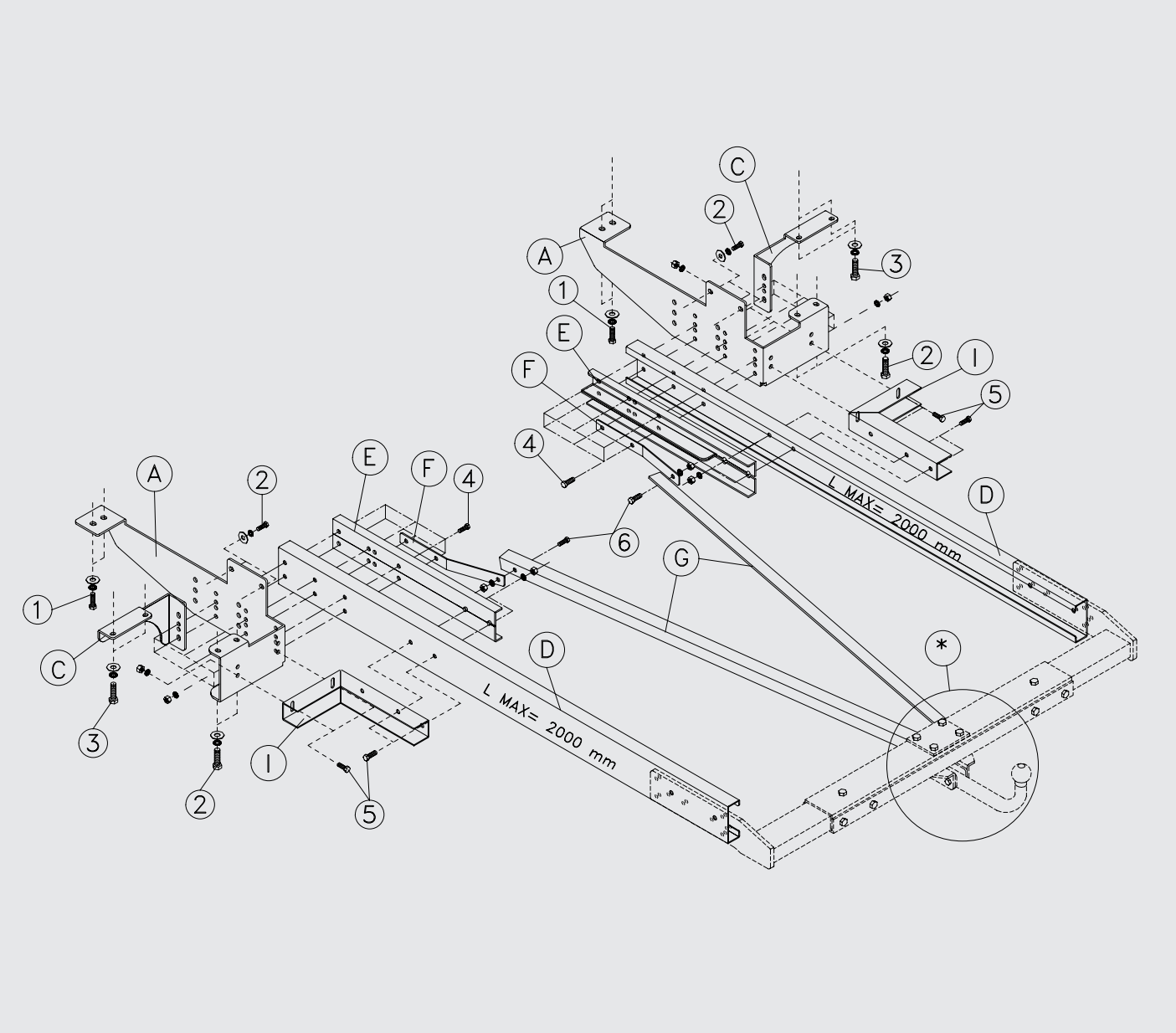

”

INNOVATION

OUR STRENGTHS

RESEARCH, TEST, COLLABORATIONS

OUR STAFF

There is constant dialogue between the planning and the production departments and this enables our Staff of technicians to create new products and to improve the already existing ones.



RESEARCH

Our main goal is to search for new materials and new manufacturing processes without compromising the strength, the reliability and the safety of the products.



TEST

Every single prototype that we are going to create undergoes severe testing before being manufactured. They are also all produced according to the EU Regulations.



COLLABORATIONS

UR has begun to cooperate with some of the most important research centres in Europe with the aim to reach high quality design standards and production and maintain low costs.

For the design, the study and the improvement of its products Umbra Rimorchi uses the most modern design technologies:

CAD DESIGN

for the creation of the first prototype, in compliance with the measures required by the design of the rear of the car on which the tow hook will be mounted.

SOLID MODELLING

to define the tridimensional shape of the products.

FEM MODELS

to verify and analyze the finished elements.

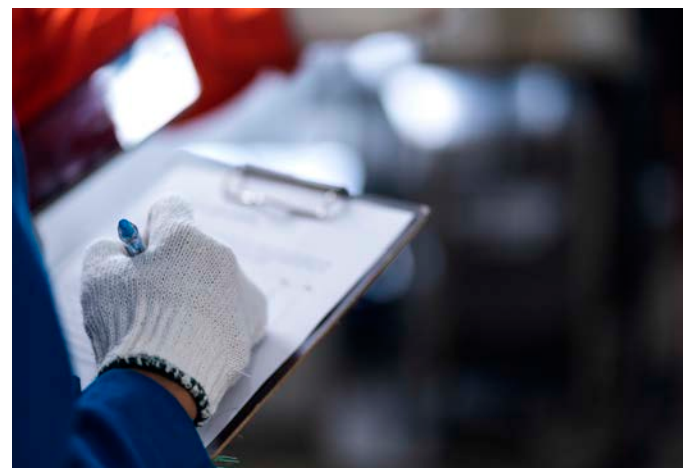
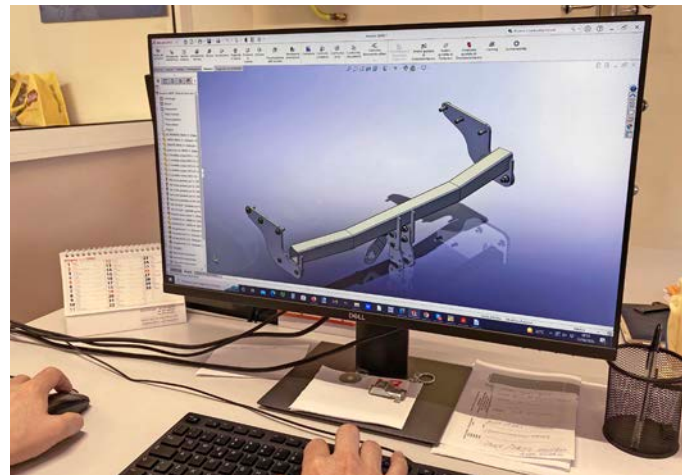

OUR BESTSELLERS

FIXED, DETACHABLE AND RETRACTABLE BALL



**MODEL F
FIXED SWAN NECK**

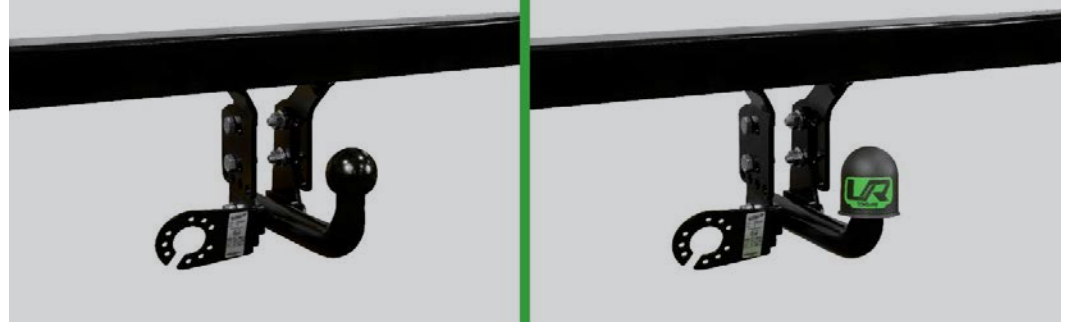

Basic solution for those who want to save as much as possible and for a more handiness device. The ball is secured to the tow beam through screws and bolts, and if needed it can still be removed through the use of a simple key.



**MODEL C
MANUALLY
DETACHABLE
BALL**

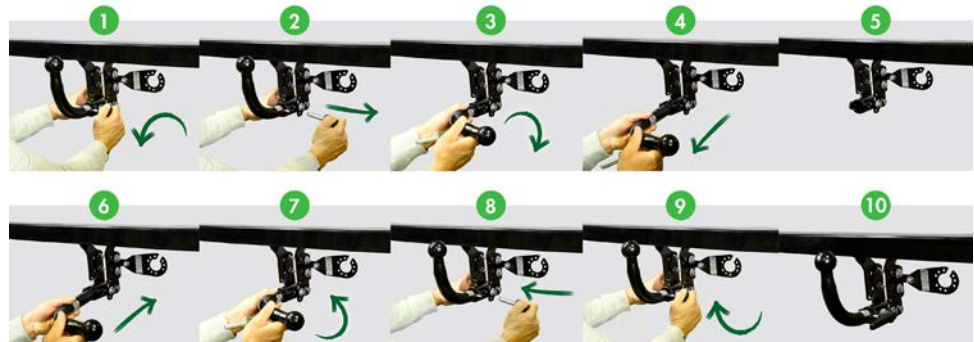

Assembly instructions

The best solution for all uses, from the professional using commercial vehicles to families that hook the trailer during their free time. The ball can be removed through the use of a lever with manual tightening and when not in use it can be placed in the boot. No tools are required, making this solution the best compromise quality / price available. The lever is also compatible to lodge an anti-theft device with key, which makes the model C optimal also from the point of view of safety.



**MODEL VM
VERTICAL
RETRACTABLE
BALL**



Assembly instructions

For those who want only the best, the top solution is the vertical ball, that once removed it makes the fitted tow bar completely invisible. The system is technologically advanced and at the same time extremely simple and it is based on a clamping mechanism with automatic key. It is designed to provide the same characteristics of strength and reliability of the other two, in other to maintain unaltered the aesthetics of the vehicle when not in use.

WIRING KITS

UNIVERSAL WITH / WITHOUT JUNCTION BOX

UNIVERSAL WIRING KITS WITHOUT JUNCTION BOX



C7
7 pin universal wiring kit
without
junction box

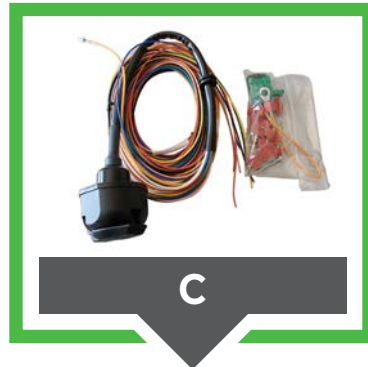

C
13 pin universal wiring kit
without
junction box

The towbar for all vehicles without check-control and in general for all those that were produced until 2003, can be simply equipped with a 7 or 13pin wiring kit. In this case it is not necessary the use of an extra junction box to guarantee the functioning of the trailer's lights.

UNIVERSAL WIRING KITS WITH JUNCTION BOX



C7+C
7 pin wiring kit
with
universal junction box



C+C
13 pin wiring kit
with
universal junction box

For the more recent vehicles, equipped with check control and with a more complex electronics, it is also necessary to install an additional junction box to allow the correct functioning of the trailer's lights. For this purpose are commercially available a large number of alternatives, with different qualitative and functional characteristics, which cover a wide range of needs.

UNIVERSAL WIRING KITS WITH JUNCTION BOX



7 pin wiring kit with universal junction box and automatic detachment of PDC (Park Distance Control)



13 pin wiring kit with universal junction box and automatic detachment of PDC (Park Distance Control)

The universal wiring kits with Umbra Rimorchi junction box guarantee the best possible money value. They are specifically designed to meet 100% the peculiarities of each target market.

⚠ WARNING:

before disconnecting the PDC sensor, it is advisable to consult with your installer. Some vehicles the operation can cause errors and it is advisable to disconnect it manually from the on-board computer.

SPECIFIC WIRING KITS



7 pin specific wiring kit with junction box



13 pin specific wiring kit with junction box

As an alternative to the Universal wiring kits, it is now available the full range of the Specific ones, that are individually designed for each vehicle and provide complete compatibility with any original electronic device.

As this product range is constantly evolving and updating, before making an order it is best to verify if the wiring is available with our sales office.

NEW WIRING KITS

AVAILABLE 2023

UNIVERSAL WIRING KITS WITH JUNCTION BOX



LIN

Adapter for cars that implement the LIN protocol

Check compatibility.

WARNING:
depending on the vehicle layout, the signal scheme may vary.

The LIN is a new signal management protocol that has recently been observed on Volkswagen group cars, including (but not only) Audi A4 crossover, Audi A4 Avant, Audi Q8 and Skoda Octavia Wagon. The LIN adapter has 6 terminals that transform data into 3 analog signals: rear lights, fog lights and position lights. On vehicles equipped with this protocol these 3 signals travel on a single cable. Using a voltmeter you can find the presence of this protocol by virtue of the 7V reading in DC, regardless of whether the lights are on or not. Brakes and arrows use a normal 12V signal instead. The trailer's position lights may be connected to the vehicle number plate lamps, which is similarly a standard 12V signal (L and R joined together).

KIT LIN

Scan the QR Code and find out the list of compatible cars (updating)



C 7 SMART

7-pin universal control unit programmable with tester functions via app



C 13 SMART

13-pin universal control unit programmable with tester functions via app

Digital version of the classic control unit, with the possibility to adjust and test electrical connections.

Adjustments and tests are performed via a Bluetooth connection on a smartphone or tablet, using the following free app on Google Play:

<https://play.google.com/store/apps/details?id=com.tpe.kareta>

Download free app on Google Play



UNIVERSAL WIRING KITS WITH JUNCTION BOX



7-pin CAN universal control unit programmable for campers and vans via app

Check compatibility.



C 7 VAN
Scan the QR Code and find out the list of compatible cars (updating)



Universal CAN control unit with 13 pins programmable for campers and vans via app

Check compatibility.



C 13 VAN
Scan the QR Code and find out the list of compatible cars (updating)

Complete electric kit that works via CAN connection.

The wiring is adapted for commercial vehicles and campers.

The electronics are universal for most commercial vehicles, programming and testing are performed via Bluetooth connection on smartphone or tablet, using the following free app available on Google Play:

<https://play.google.com/store/apps/details?id=com.tpe.kareta.can.tpe>

Download free app on Google Play



CHOOSE THE RIGHT WIRING KIT FOR YOU

CHECK OUT OUR WEBSITE AND DISCOVER ALL THE AVAILABLE WIRING KITS



KEY FOR TOWBARS



CAR MODEL



VERSIONS



TOWBAR CODE



FUNCTIONAL TYPE



START PRODUCTION



END PRODUCTION



BUMPER REMOVAL



BUMPER'S CUT

V = I =



TOWING DISPOSAL



MAX TOWING CAPACITY



S VALUE



D VALUE































PRICE + VAT

















RECOMMENDED WIRING KIT















SIMPLE WIRING KIT
 WIRING WITH CONTROL UNIT





													
ALFA ROMEO													
145	HATCHBACK 3 doors	01049	930 A	94		x		C	1300	50	7,66	239,56	x
147	HATCHBACK 3-5 doors	01057/F	937	01/00		x		F	1300	60	8,20	233,20	x
147	HATCHBACK 3-5 doors	01057	937	01/00		x		C	1300	60	8,20	279,84	x
156	Saloon, visible bumper cut only on the 1st series	01053/F	932, NUOVA ALLCAR AC-14	10/97	05/06		v	F	1400	60	8,80	196,10	x
156	Saloon, visible bumper cut only on the 1st series	01053/C	932, NUOVA ALLCAR AC-14	10/97	05/06		v	C	1400	60	8,80	267,12	x
156 CROSSWAGON Q4	SUV, visible bumper cut only on the 1st series	01053/F	932, NUOVA ALLCAR AC-14	97	05/06		v	F	1400	60	8,80	196,10	x
156 CROSSWAGON Q4	SUV, visible bumper cut only on the 1st series	01053/C	932, NUOVA ALLCAR AC-14	97	05/06		v	C	1400	60	8,80	267,12	x
156 SPORTWAGON	ESTATE, visible bumper cut only on the 1st series	01053/F	932, NUOVA ALLCAR AC-14	97	05/06		v	F	1400	60	8,80	196,10	x
156 SPORTWAGON	ESTATE, visible bumper cut only on the 1st series	01053/C	932, NUOVA ALLCAR AC-14	97	05/06		v	C	1400	60	8,80	267,12	x
156 SPORTWAGON Q4	ESTATE 4X4, visible bumper cut only on the 1st series	01053/F	932, NUOVA ALLCAR AC-14	97	05/06		v	F	1400	60	8,80	196,10	x
156 SPORTWAGON Q4	ESTATE 4X4, visible bumper cut only on the 1st series	01053/C	932, NUOVA ALLCAR AC-14	97	05/06		v	C	1400	60	8,80	267,12	x
159	Saloon	01055/F	939	11/05		x	v	F	1800	75	10,70	220,48	x
159	Saloon	01055/C	939	11/05		x	v	C	1800	75	10,70	318,00	x
159	Saloon	01055/M	939	11/05		x	v	M	1800	75	10,70	405,98	x
159 SPORTWAGON	ESTATE	01055/F	939	04/06		x	v	F	1800	75	10,70	220,48	x
159 SPORTWAGON	ESTATE	01055/C	939	04/06		x	v	C	1800	75	10,70	318,00	x
159 SPORTWAGON	ESTATE	01055/M	939	04/06		x	v	M	1800	75	10,70	405,98	x
159 SPORTWAGON Q4	ESTATE 4x4	01055/F	939	04/06		x	v	F	1800	75	10,70	220,48	x
159 SPORTWAGON Q4	ESTATE 4x4	01055/C	939	04/06		x	v	C	1800	75	10,70	318,00	x
159 SPORTWAGON Q4	ESTATE 4x4	01055/M	939	04/06		x	v	M	1800	75	10,70	405,98	x
166	Saloon	01051	936 A	98		x	v	C	1500	60	9,40	299,98	x
GIULIA	Saloon, no petrol	01058/F	952	06/16		x	v	F	1688	64	9,20	192,92	x
GIULIA	Saloon, no petrol	01058/C	952	06/16		x	v	C	1688	64	9,20	289,38	x
GIULIA	Saloon, no petrol	01058/VM	952	06/16		x	v	VM	1688	64	9,20	351,92	x
GIULIETTA	HATCHBACK 3-5 doors	01056/F	940	04/10		x	i	F	1300	60	8,00	208,82	x
GIULIETTA	HATCHBACK 3-5 doors	01056/C	940	04/10		x	i	C	1300	60	8,00	293,62	x
GIULIETTA	HATCHBACK 3-5 doors	01056/VM	940	04/10		x	i	VM	1300	60	8,00	383,72	x
GT	COUPÈ	01053/1F	937	01/04			i	F	1400	60	8,80	208,82	x
GT	COUPÈ	01053/1C	937	01/04			i	C	1400	60	8,80	267,12	x
MITO	HATCHBACK 3-5 doors, LPG	13149/F	955	09/08		x	i	F	1000	75	7,50	171,72	x
MITO	HATCHBACK 3-5 doors, LPG	13149/C	955	09/08		x	i	C	1000	75	7,50	239,56	x
MITO	HATCHBACK 3-5 doors, LPG	13149/VM	955	09/08		x	i	VM	1000	75	7,50	338,14	x
STELVIO	2-4WD, Q4, Pack Veloce	01059/F	949	01/17		x	i	F	2575	95	12,00	192,92	x
STELVIO	2-4WD, Q4, Pack Veloce	01059/C	949	01/17		x	i	C	2575	95	12,00	294,68	x
STELVIO	2-4WD, Q4, Pack Veloce	01059/VM	949	01/17		x	i	VM	2575	95	12,00	358,28	x
TONALE	SUV, HYBRID	01060/F	AV1	03/22		x	i	F	2146	75	10,50	245,00	x
TONALE	SUV, HYBRID	01060/C	AV1	03/22		x	i	C	2146	75	10,50	315,00	x
TONALE	SUV, HYBRID	01060/VM	AV1	03/22		x	i	VM	2146	75	10,50	395,00	x

















														
AUDI														
A1	HATCHBACK 3 doors, S-LINE	43058S/F	8XA, 8XS	08/10	10/18	x	i	F	1200	50	7,50	178,08		x
A1	HATCHBACK 3 doors, S-LINE	43058S/C	8XA, 8XS	08/10	10/18	x	i	C	1200	50	7,50	216,24		x
A1	HATCHBACK 3 doors, S-LINE	43058S/VM	8XA, 8XS	08/10	10/18	x	i	VM	1200	50	7,50	345,56		x
A1	HATCHBACK 3 doors, no S-LINE	43058/VM	8XA, 8XS	08/10	10/18	x	i	VM	1200	50	7,50	313,76		x
A1 SPORTBACK	HATCHBACK 5 doors, S-LINE	43058S/F	8XA, 8XS	10	10/18	x	i	F	1200	50	7,50	178,08		x
A1 SPORTBACK	HATCHBACK 5 doors, S-LINE	43058S/C	8XA, 8XS	10	10/18	x	i	C	1200	50	7,50	216,24		x
A1 SPORTBACK	HATCHBACK 5 doors, S-LINE	43058S/VM	8XA, 8XS	10	10/18	x	i	VM	1200	50	7,50	345,56		x
A1 SPORTBACK	HATCHBACK 5 doors, no S-LINE	43058/VM	8XA, 8XS	10	10/18	x	i	VM	1200	50	7,50	313,76		x
A3	HATCHBACK 3-5 doors no QUATTRO	02020	8L	09/96	06/03	x		C	1500	75	8,50	238,50		x
A3	HATCHBACK 3-5 doors no QUATTRO	02020/F	8L	09/96	06/03	x		F	1500	75	8,50	151,58		x
A3	HATCHBACK 3-5 doors L=4.203,QUATTRO, S-LINE, no S3, no model with parking sensors	02033/F	8P, 8V	01/03	07/12	x	v	F	2190	80	10,35	147,34		x
A3	HATCHBACK 3-5 doors L=4.203,QUATTRO, S-LINE, no S3, no model with parking sensors	02033/C	8P, 8V	01/03	07/12	x	v	C	2190	80	10,35	270,30		x
A3	HATCHBACK 3-5 doors L=4.203,QUATTRO, S-LINE, no S3, no model with parking sensors	02033/VM	8P, 8V	01/03	07/12	x	v	VM	2190	80	10,35	338,14		x
A3	HATCHBACK 3 doors L=4.203, QUATTRO, S-LINE, no saloon, no S3	02033/F	8P, 8V	07/12	12/15	x	v	F	2190	80	10,35	147,34		x
A3	HATCHBACK 3 doors L=4.203, QUATTRO, S-LINE, no saloon, no S3	02033/C	8P, 8V	07/12	12/15	x	v	C	2190	80	10,35	270,30		x
A3	HATCHBACK 3 doors L=4.203, QUATTRO, S-LINE, no Saloon, no S3	02033/VM	8P, 8V	07/12	12/15	x	v	VM	2190	80	10,35	338,14		x
A3 SPORTBACK	HATCHBACK 5 doors, QUATTRO, no S- LINE, no S3	02026/F	8P	01/04	01/13	x	v	F	1600	75	9,40	147,34		x
A3 SPORTBACK	HATCHBACK 5 doors, QUATTRO, no S- LINE, no S3	02026/C	8P	01/04	01/13	x	v	C	1600	75	9,40	270,30		x
A3 SPORTBACK	HATCHBACK 5 doors, QUATTRO, no S- LINE, no S3	02026/VM	8P	01/04	01/13	x	v	VM	1600	75	9,40	338,14		x
A3 SPORTBACK	HATCHBACK 5 doors, QUATTRO, g-tron, S-LINE, no S3	02033/F	8VS	02/13	10/16	x	v	F	2190	80	10,35	147,34		x
A3 SPORTBACK	HATCHBACK 5 doors, QUATTRO, g-tron, S-LINE, no S3	02033/C	8VS	02/13	10/16	x	v	C	2190	80	10,35	270,30		x
A3 SPORTBACK	HATCHBACK 5 doors, QUATTRO, g-tron, S-LINE, no S3, invisible bumper cut with original spoiler	02033/VM	8VS	02/13	10/16	x	v	VM	2190	80	10,35	338,14		x
A3 SPORTBACK	HATCHBACK 5 doors, QUATTRO, g-tron, S-LINE, no S3	43063/F	8VS	11/16	10/19	x		F	2652	90	12,00	196,10		x
A3 SPORTBACK	HATCHBACK 5 doors, QUATTRO, g-tron, S-LINE, no S3	43063/C	8VS	11/16	10/19	x		C	2652	90	12,00	288,32		x
A3 SPORTBACK	HATCHBACK 5 doors, QUATTRO, g-tron, S-LINE, no S3	43063/VM	8VS	11/16	10/19	x		VM	2652	90	12,00	380,54		x
A3 SPORTBACK	G-Tron, S-Line	33023/F	GY	11/19		x	i	F	2575	100	12,20	163,24		x
A3 SPORTBACK	G-Tron, S-Line	33023/C	GY	11/19		x	i	C	2575	100	12,20	262,88		x
A3 SPORTBACK	G-Tron, S-Line	33023/VM	GY	11/19		x		VM	2575	100	12,20	318,00		x
A4	Saloon, QUATTRO, no S4, no RS4	02023/F	8E	01/01	12/04	x	i	F	1800	80	10,50	181,26		x
A4	Saloon, QUATTRO, no S4, no RS4	02023/C	8E	01/01	12/04	x	i	C	1800	80	10,50	307,40		x
A4	Saloon, QUATTRO, no S4, no RS4	02027/F	8E	01/05	12/07	x	i	F	1800	80	10,50	160,06		x
A4	Saloon, QUATTRO, no S4, no RS4	02027/C	8E	01/05	12/07	x	i	C	1800	80	10,50	288,32		x















													
A4	Saloon, QUATTRO, no S4, no RS4	02027/VM	8E	01/05	12/07	x	i	VM	1800	80	10,50	361,46	x
A4	Saloon, QUATTRO, S-LINE, no S4, no RS4, it may be necessary to adapt the vehicle's cooling system	02028/F	B8A, B8L	11/07	11/15	x	i	F	1900	80	11,00	171,72	x
A4	Saloon, QUATTRO, S-LINE, no S4, no RS4, it may be necessary to adapt the vehicle's cooling system	02028/C	B8A, B8L	11/07	11/15	x	i	C	1900	80	11,00	309,52	x
A4	Saloon, QUATTRO, S-LINE, no S4, no RS4, it may be necessary to adapt the vehicle's cooling system	02028/VM	B8A, B8L	11/07	11/15	x	i	VM	1900	80	11,00	398,56	x
A4	Saloon, Quattro, S-line	02032/F	B8	12/15		x	i	F	2364	80	11,60	170,66	x
A4	Saloon, Quattro, S-line	02032/C	B8	12/15		x	i	C	2364	80	11,60	272,42	x
A4	Saloon, Quattro, S-line	02032/VM	B8	12/15		x	i	VM	2364	80	11,60	319,06	x
A4 ALLROAD	ESTATE, QUATTRO, no S4, no RS4, it may be necessary to adapt the vehicle's cooling system	02028/F	B8A, B8L	01/12	11/15	x	i	F	1900	80	11,00	171,72	x
A4 ALLROAD	ESTATE, QUATTRO, no S4, no RS4, it may be necessary to adapt the vehicle's cooling system	02028/C	B8A, B8L	01/12	11/15	x	i	C	1900	80	11,00	309,52	x
A4 ALLROAD	ESTATE, QUATTRO, no S4, no RS4, it may be necessary to adapt the vehicle's cooling system	02028/VM	B8A, B8L	01/12	11/15	x	i	VM	1900	80	11,00	398,56	x
A4 ALLROAD	ESTATE, Quattro	02032/F	B8	12/15		x	i	F	2364	80	11,60	170,66	x
A4 ALLROAD	ESTATE, Quattro	02032/C	B8	12/15		x	i	C	2364	80	11,60	272,42	x
A4 ALLROAD	ESTATE, Quattro	02032/VM	B8	12/15		x	i	VM	2364	80	11,60	319,06	x
A4 ALLROAD	HYBRID	02040/F	B8	07/18		x	i	F	2364	80	11,60	212,00	x
A4 ALLROAD	HYBRID	02040/C	B8	07/18		x	i	C	2364	80	11,60	296,80	x
A4 ALLROAD	HYBRID	02040/VM	B8	07/18		x	i	VM	2364	80	11,60	402,80	x
A4 AVANT	ESTATE, QUATTRO, no S4, no RS4	02023/F	8E	01/01	12/04	x	i	F	1800	80	10,50	181,26	x
A4 AVANT	ESTATE, QUATTRO, no S4, no RS4	02023/C	8E	01/01	12/04	x	i	C	1800	80	10,50	307,40	x
A4 AVANT	ESTATE, QUATTRO, no S4, no RS4	02027/F	8E	01/05	04/08	x	i	F	1800	80	10,50	160,06	x
A4 AVANT	ESTATE, QUATTRO, no S4, no RS4	02027/C	8E	01/05	04/08	x	i	C	1800	80	10,50	288,32	x
A4 AVANT	ESTATE, QUATTRO, no S4, no RS4	02027/VM	8E	01/05	04/08	x	i	VM	1800	80	10,50	361,46	x
A4 AVANT	ESTATE, QUATTRO, S-LINE, no S4, no RS4, it may be necessary to adapt the vehicle's cooling system	02028/F	B8A, B8L	04/08	11/15	x	i	F	1900	80	11,00	171,72	x
A4 AVANT	ESTATE, QUATTRO, S-LINE, no S4, no RS4, it may be necessary to adapt the vehicle's cooling system	02028/C	B8A, B8L	04/08	11/15	x	i	C	1900	80	11,00	309,52	x
A4 AVANT	ESTATE, QUATTRO, S-LINE, no S4, no RS4, it may be necessary to adapt the vehicle's cooling system	02028/VM	B8A, B8L	04/08	11/15	x	i	VM	1900	80	11,00	398,56	x
A4 AVANT	ESTATE, Quattro, S-line, g-tron	02032/F	B8	12/15		x	i	F	2364	80	11,60	170,66	x
A4 AVANT	ESTATE, Quattro, S-line, g-tron	02032/C	B8	12/15		x	i	C	2364	80	11,60	272,42	x
A4 AVANT	ESTATE, Quattro, S-line, g-tron	02032/VM	B8	12/15		x	i	VM	2364	80	11,60	319,06	x
A4-S4	Saloon, QUATTRO from year 1999 up to EXT. 187	02018	B5	11/94	02/99	x	v	C	1800	75	10,00	285,14	x
A4-S4	Saloon, QUATTRO from year 1999 up to EXT. 187	02018/F	B5	11/94	02/99	x	v	F	1800	75	10,00	221,54	x
A4-S4	Saloon, QUATTRO from year 1999 from EXT. 188	02022	B5	03/99	10/00	x	v	C	1800	75	10,00	301,04	x
A4-S4	Saloon, QUATTRO from year 1999 from EXT. 188	02022/F	B5	03/99	10/00	x	v	F	1800	75	10,00	221,54	x















													
A4-S4 AVANT	ESTATE, QUATTRO from year 1999 up to EXT. 187	02018	B5	94	99	x	v	C	1800	75	10,00	285,14	x
A4-S4 AVANT	ESTATE, QUATTRO from year 1999 from EXT. 188	02022	B5	99	00	x	v	C	1800	75	10,00	301,04	x
A4-S4 AVANT	ESTATE, QUATTRO from year 1999 from EXT. 188	02022/F	B5	99	0	x	v	F	1800	75	10,00	221,54	x
A5	CABRIOLET, QUATTRO, S-LINE, no S5, no RS5, it may be necessary to adapt the vehicle's cooling system	02028/F	B8A, B8C, B8L, B8S, B8K	08/09	06/16	x	i	F	1900	80	11,00	171,72	x
A5	CABRIOLET, QUATTRO, S-LINE, no S5, no RS5, it may be necessary to adapt the vehicle's cooling system	02028/C	B8A, B8C, B8L, B8S, B8K	08/09	06/16	x	i	C	1900	80	11,00	309,52	x
A5	CABRIOLET, QUATTRO, S-LINE, no S5, no RS5, it may be necessary to adapt the vehicle's cooling system	02028/VM	B8A, B8C, B8L, B8S, B8K	08/09	06/16	x	i	VM	1900	80	11,00	398,56	x
A5	COUPÈ, QUATTRO, S-LINE, no S5, no RS5, it may be necessary to adapt the vehicle's cooling system	02028/F	B8A, B8C, B8L, B8S, B8K	06/07	06/16	x	i	F	1900	80	11,00	171,72	x
A5	COUPÈ, QUATTRO, S-LINE, no S5, no RS5, it may be necessary to adapt the vehicle's cooling system	02028/C	B8A, B8C, B8L, B8S, B8K	06/07	06/16	x	i	C	1900	80	11,00	309,52	x
A5	COUPÈ, QUATTRO, S-LINE, no S5, no RS5, it may be necessary to adapt the vehicle's cooling system	02028/VM	B8A, B8C, B8L, B8S, B8K	06/07	06/16	x	i	VM	1900	80	11,00	398,56	x
A5	COUPE', quattro, S-Line	02032/F	B8	07/16		x	i	F	2364	80	11,60	170,66	x
A5	COUPE', quattro, S-Line	02032/C	B8	07/16		x	i	C	2364	80	11,60	272,42	x
A5	COUPE', quattro, S-Line	02032/VM	B8	07/16		x	i	VM	2364	80	11,60	319,06	x
A5 SPORTBACK	Saloon 5 doors, QUATTRO, S-LINE, it may be necessary to adapt the vehicle's cooling system	02028/F	8S	08/09	06/16	x	i	F	1900	80	11,00	171,72	x
A5 SPORTBACK	Saloon 5 doors, QUATTRO, S-LINE, it may be necessary to adapt the vehicle's cooling system	02028/C	8S	08/09	06/16	x	i	C	1900	80	11,00	309,52	x
A5 SPORTBACK	Saloon 5 doors, QUATTRO, S-LINE, it may be necessary to adapt the vehicle's cooling system	02028/VM	8S	08/09	06/16	x	i	VM	1900	80	11,00	398,56	x
A5 SPORTBACK	Saloon 5 doors, QUATTRO, S-LINE, it may be necessary to adapt the vehicle's cooling system	02032/F	B8	07/16		x	i	F	2364	80	11,60	170,66	x
A5 SPORTBACK	Saloon 5 doors, QUATTRO, S-LINE, it may be necessary to adapt the vehicle's cooling system	02032/C	B8	07/16		x	i	C	2364	80	11,60	272,42	x
A5 SPORTBACK	Saloon 5 doors, QUATTRO, S-LINE, it may be necessary to adapt the vehicle's cooling system	02032/VM	B8	07/16		x	i	VM	2364	80	11,60	319,06	x
A6 ALLROAD	ESTATE, QUATTRO	02030/F	4G	11/11	06/19	x	i	F	2500	140	12,70	184,44	x
A6 ALLROAD	ESTATE, QUATTRO	02030/VM	4G	11/11	06/19	x	i	VM	2500	140	12,70	361,46	x
A6 ALLROAD	ESTATE, QUATTRO, check D value	02035/F	F2	07/19		x	i	F	2154	95	11,30	181,26	x
A6 ALLROAD	ESTATE, QUATTRO, check D value	02035/C	F2	07/19		x	i	C	2154	95	11,30	326,48	x
A6 ALLROAD	ESTATE, QUATTRO, check D value	02035/VM	F2	07/19		x	i	VM	2154	95	11,30	365,70	x
A6 ALLROAD	QUATTRO, HYBRID, check D value	02039/F	F2	07/19		x	i	F	2154	95	11,30	202,46	x
A6 ALLROAD	QUATTRO, HYBRID, check D value	02039/C	F2	07/19		x	i	C	2154	95	11,30	337,08	x
A6 ALLROAD	QUATTRO, HYBRID, check D value	02039/VM	F2	07/19		x	i	VM	2154	95	11,30	386,90	x
A6-S6	Saloon, QUATTRO, no ALLROAD	02021/F	4B	01/97	03/04	x	v	F	1900	85	10,80	221,54	x











													
A6-S6	Saloon, QUATTRO, no ALLROAD	02021	4B	01/97	03/04	x	v	C	1900	85	10,80	301,04	x
A6-S6	Saloon, QUATTRO, no ALLROAD	02025/F	4F	05/04	04/11	x	i	F	2100	85	11,30	184,44	x
A6-S6	Saloon, QUATTRO, no ALLROAD	02025/C	4F	05/04	04/11	x	i	C	2100	85	11,30	288,32	x
A6-S6	Saloon, QUATTRO, no ALLROAD	02025/VM	4F	05/04	04/11	x	i	VM	2100	85	11,30	361,46	x
A6-S6	Saloon, QUATTRO	02030/F	4G	05/11	06/18	x	i	F	2500	140	12,70	184,44	x
A6-S6	Saloon, QUATTRO	02030/VM	4G	05/11	06/18	x	i	VM	2500	140	12,70	361,46	x
A6	Saloon, QUATTRO, S-LINE	02035/F	F2	07/18		x	i	F	2154	95	11,30	181,26	x
A6	Saloon, QUATTRO, S-LINE	02035/C	F2	07/18		x	i	C	2154	95	11,30	326,48	x
A6	Saloon, QUATTRO, S-LINE	02035/VM	F2	07/18		x	i	VM	2154	95	11,30	365,70	x
A6-S6 AVANT	ESTATE, QUATTRO, no ALLROAD	02021/F	4B	04/98	04/05	x	v	F	1900	85	10,80	221,54	x
A6-S6 AVANT	ESTATE, QUATTRO, no ALLROAD	02021	4B	04/98	04/05	x	v	C	1900	85	10,80	301,04	x
A6-S6 AVANT	ESTATE, QUATTRO, no ALLROAD	02025/F	4F	03/05	10/11	x	i	F	2100	85	11,30	184,44	x
A6-S6 AVANT	ESTATE, QUATTRO, no ALLROAD	02025/C	4F	03/05	10/11	x	i	C	2100	85	11,30	288,32	x
A6-S6 AVANT	ESTATE, QUATTRO, no ALLROAD	02025/VM	4F	03/05	10/11	x	i	VM	2100	85	11,30	361,46	x
A6-S6 AVANT	ESTATE, QUATTRO, S-LINE	02030/F	4G	11/11	08/18	x	i	F	2500	140	12,70	184,44	x
A6-S6 AVANT	ESTATE, QUATTRO, S-LINE	02030/VM	4G	11/11	08/18	x	i	VM	2500	140	12,70	361,46	x
A6 AVANT	ESTATE, QUATTRO, S-LINE	02035/F	F2	09/18		x	i	F	2154	95	11,30	181,26	x
A6 AVANT	ESTATE, QUATTRO, S-LINE	02035/C	F2	09/18		x	i	C	2154	95	11,30	326,48	x
A6 AVANT	ESTATE, QUATTRO, S-LINE	02035/VM	F2	09/18		x	i	VM	2154	95	11,30	365,70	x
A7 SPORTBACK	Saloon 5 doors, QUATTRO	02030/F	4G	01/11	12/17	x	i	F	2500	140	12,70	184,44	x
A7 SPORTBACK	Saloon 5 doors, QUATTRO	02030/VM	4G	01/11	12/17	x	i	VM	2500	140	12,70	361,46	x
A7 SPORTBACK	QUATTRO, S-LINE	02035/F	F2	01/18		x	i	F	2154	95	11,30	181,26	x
A7 SPORTBACK	QUATTRO, S-LINE	02035/C	F2	01/18		x	i	C	2154	95	11,30	326,48	x
A7 SPORTBACK	QUATTRO, S-LINE	02035/VM	F2	01/18		x	i	VM	2154	95	11,30	365,70	x
Q2	2-4WD, Quattro, S-Line	02033/QF	GA	11/16		x		F	2190	80	10,35	169,60	x
Q2	2-4WD, Quattro, S-Line	02033/QC	GA	11/16		x		C	2190	80	10,35	279,84	x
Q2	2-4WD, Quattro, S-Line	02033/QVM	GA	11/16		x		VM	2190	80	10,35	349,80	x
Q3	2-4WD S-Line	33023/F	8U	11/11	10/18	x	v	F	2575	100	12,20	163,24	x
Q3	2-4WD S-Line	33023/C	8U	11/11	10/18	x	v	C	2575	100	12,20	262,88	x
Q3	2-4WD S-Line	33023/VM	8U	11/11	10/18	x	v	VM	2575	100	12,20	318,00	x
Q3	2-4WD S-Line	33023/F	F3	11/18		x		F	2575	100	12,20	163,24	x
Q3	2-4WD S-Line	33023/C	F3	11/18		x		C	2575	100	12,20	262,88	x
Q3	2-4WD S-Line	33023/VM	F3	11/18		x		VM	2575	100	12,20	318,00	x
Q3 SPORTBACK	Suv Coupé, AdBlue, S-LINE	33023/F	F3	01/19		x		F	2575	100	12,20	163,24	x
Q3 SPORTBACK	Suv Coupé, AdBlue, S-LINE	33023/C	F3	01/19		x		C	2575	100	12,20	262,88	x
Q3 SPORTBACK	Suv Coupé, AdBlue, S-LINE	33023/VM	F3	01/19		x		VM	2575	100	12,20	318,00	x
Q5	SUV 2-4WD, check D value, S-LINE, it may be necessary to adapt the vehicle's cooling system	02029/F	8R	11/08	12/16	x	i	F	2000	80	11,30	208,82	x
Q5	SUV 2-4WD, check D value, S-LINE, it may be necessary to adapt the vehicle's cooling system	02029/C	8R	11/08	12/16	x	i	C	2000	80	11,30	309,52	x
Q5	SUV 2-4WD, check D value, S-LINE, it may be necessary to adapt the vehicle's cooling system	02029/VM	8R	11/08	12/16	x	i	VM	2000	80	11,30	398,56	x
Q5	SUV 2-4WD, S-LINE	02034/F	FY	01/17		x	v	F	2666	100	12,50	208,82	x
Q5	SUV 2-4WD, S-LINE	02034/C	FY	01/17		x	v	C	2666	100	12,50	309,52	x
Q5	SUV 2-4WD, S-LINE	02034/VM	FY	01/17		x	v	VM	2666	100	12,50	398,56	x















													
Q5 SPORTBACK	SUV	02034/F	FY	10/20		x	v	F	2666	100	12,50	208,82	x
Q5 SPORTBACK	SUV	02034/C	FY	10/20		x	v	C	2666	100	12,50	309,52	x
Q5 SPORTBACK	SUV	02034/VM	FY	10/20		x	v	VM	2666	100	12,50	398,56	x
Q5	HYBRID	02037/F	FY	01/17		x	v	F	2666	100	12,50	312,70	x
Q5	HYBRID	02037/C	FY	01/17		x	v	C	2666	100	12,50	355,10	x
Q5	HYBRID	02037/VM	FY	01/17		x	v	VM	2666	100	12,50	450,50	x
Q5 SPORTBACK	SUV, HYBRID	02037/F	FY	06/21		x	v	F	2666	100	12,50	312,70	x
Q5 SPORTBACK	SUV, HYBRID	02037/C	FY	06/21		x	v	C	2666	100	12,50	355,10	x
Q5 SPORTBACK	SUV, HYBRID	02037/VM	FY	06/21		x	v	VM	2666	100	12,50	450,50	x
Q7	SUV 4WD, check D value	43053/F	4L	03/06	06/15	x	v	F	3500	140	16,52	221,54	x
Q7	SUV 4WD, check D value	43053	4L	03/06	06/15	x	v	VM	3500	140	16,52	398,56	x
BMW													
1 SERIES	HATCHBACK 3-5 doors	06026/1F	187, 1K2, 1K4	09/04	11	x		F	1200	75	10,40	171,72	x
1 SERIES	HATCHBACK 3-5 doors	06026/1C	187, 1K2, 1K4	09/04	11	x		C	1200	75	10,40	241,68	x
1 SERIES	HATCHBACK 3-5 doors	06026/1VM	187, 1K2, 1K4	09/04	11	x		VM	1200	75	10,40	337,08	x
1 SERIES	HATCHBACK 3-5 doors, no M Sport, Restyling '14, AdBlue, (no 120D, no 118i)	06033/F	1K	11	06/19	x		F	1200	95	10,20	171,72	x
1 SERIES	HATCHBACK 3-5 doors, no M Sport, Restyling '14, AdBlue, (no 120D, no 118i)	06033/C	1K	11	06/19	x		C	1200	95	10,20	276,66	x
1 SERIES	HATCHBACK 3-5 doors, no M Sport, Restyling '14, AdBlue, (no 120D, no 118i)	06033/VM	1K	11	06/19	x		VM	1200	95	10,20	355,10	x
1 SERIES	HATCHBACK 3-5 doors, also for M sport bumper, AdBlue	06038/F	F1H (F40)	07/19		x	i	F	2086	80	10,70	167,48	x
1 SERIES	HATCHBACK 3-5 doors, also for M sport bumper, AdBlue	06038/C	F1H (F40)	07/19		x	i	C	2086	80	10,70	274,54	x
1 SERIES	HATCHBACK 3-5 doors, also for M sport bumper, AdBlue	06038/VM	F1H (F40)	07/19		x	i	VM	2086	80	10,70	355,10	x
2 SERIES	COUPE', also for M sport bumper	06033/F	1C	03/14		x		F	1800	95	10,20	171,72	x
2 SERIES	COUPE', also for M sport bumper	06033/C	1C	03/14		x		C	1800	95	10,20	276,66	x
2 SERIES	COUPE', also for M sport bumper	06033/VM	1C	03/14		x		VM	1800	95	10,20	355,10	x
2 SERIES GRAN COUPÈ	saloon-coupé (F44)	06038/F	F2G	10/19		x		F	2086	80	10,70	167,48	x
2 SERIES GRAN COUPÈ	saloon-coupé (F44)	06038/C	F2G	10/19		x		C	2086	80	10,70	274,54	x
2 SERIES GRAN COUPÈ	saloon-coupé (F44)	06038/VM	F2G	10/19		x		VM	2086	80	10,70	355,10	x
3 SERIES	Saloon	06017	3B, 3C	91	04/98	x	v	C	1500	75		241,68	x
3 SERIES	Saloon, check D value	06034/F	346	04/98	02/05	x	i	F	1800	75	10,00	171,72	x
3 SERIES	Saloon, check D value	06034/C	346	04/98	02/05	x	i	C	1800	75	10,00	276,66	x
3 SERIES	Saloon, check D value	06034/VM	346	04/98	02/05	x	i	VM	1800	75	10,00	355,10	x
3 SERIES	Saloon E90, no COUPÈ, no M Sport	06026/1F	390L, 390X, 3K, 3L	01/05	11	x	i	F	1800	75	10,40	171,72	x
3 SERIES	Saloon E90, no COUPÈ, no M Sport	06026/1C	390L, 390X, 3K, 3L	01/05	11	x	i	C	1800	75	10,40	241,68	x
3 SERIES	Saloon E90, no COUPÈ, no M Sport	06026/1VM	390L, 390X, 3K, 3L	01/05	11	x	i	VM	1800	75	10,40	337,08	x
3 SERIES	Saloon F30, M Sport	06033/F	3L, 3K	12	12/18	x		F	1800	95	10,20	171,72	x
3 SERIES	Saloon F30, M Sport	06033/C	3L, 3K	12	12/18	x		C	1800	95	10,20	276,66	x















															
3 SERIES	Saloon F30, M Sport	06033/VM	3L, 3K	12	12/18	x		VM	1800	95	10,20	355,10	x		
3 SERIES	Saloon G20, no M3, M Sport type bumper	06037/F	G3L	01/19		x	i	F	2222	90	12,00	174,90	x		
3 SERIES	Saloon G20, no M3, M Sport type bumper	06037/C	G3L	01/19		x	i	C	2222	90	12,00	291,50	x		
3 SERIES	Saloon G20, no M3, M Sport type bumper	06037/VM	G3L	01/19		x	i	VM	2222	90	12,00	371,00	x		
3 SERIES	CABRIO, check D value	06034/F	346	98	05	x	i	F	1800	75	10,00	171,72	x		
3 SERIES	CABRIO, check D value	06034/C	346	98	05	x	i	C	1800	75	10,00	276,66	x		
3 SERIES	CABRIO, check D value	06034/VM	346	98	05	x	i	VM	1800	75	10,00	355,10	x		
3 SERIES	COMPACT	06018	3CG, 316 1/7	05/94	05/01	x		C	1600	75	8,50	267,12	x		
3 SERIES	COMPACT	06022/C	346K	06/01	02/05	x	v	C	1600	75	9,20	329,66	x		
3 SERIES	COUPÈ	06017	3B, 3C	03/92	03/99	x	v	C	1500	75		241,68	x		
3 SERIES	COUPÈ, check D value	06034/F	346	04/99	08/06	x	i	F	1800	75	10,00	171,72	x		
3 SERIES	COUPÈ, check D value	06034/C	346	04/99	08/06	x	i	C	1800	75	10,00	276,66	x		
3 SERIES	COUPÈ, check D value	06034/VM	346	04/99	08/06	x	i	VM	1800	75	10,00	355,10	x		
3 SERIES	GT	06035/F	3-V	13		x	i	F	1800	75	10,20	184,44	x		
3 SERIES	GT	06035/C	3-V	13		x	i	C	1800	75	10,20	294,68	x		
3 SERIES	GT	06035/VM	3-V	13		x	i	VM	1800	75	10,20	390,08	x		
3 SERIES TOURING	ESTATE	06017	3B, 3C	91	08/99	x	v	C	1500	75		241,68	x		
3 SERIES TOURING	ESTATE, check D value	06034/F	346	04/99	09/05	x	i	F	1800	75	10,00	171,72	x		
3 SERIES TOURING	ESTATE, check D value	06034/C	346	04/99	09/05	x	i	C	1800	75	10,00	276,66	x		
3 SERIES TOURING	ESTATE, check D value	06034/VM	346	04/99	09/05	x	i	VM	1800	75	10,00	355,10	x		
3 SERIES TOURING	ESTATE E91, no COUPÈ, no M Sport	06026/1F	390L, 390X, 3K, 3L	09/05	11	x	i	F	1800	75	10,40	171,72	x		
3 SERIES TOURING	ESTATE E91, no COUPÈ, no M Sport	06026/1C	390L, 390X, 3K, 3L	09/05	11	x	i	C	1800	75	10,40	241,68	x		
3 SERIES TOURING	ESTATE E91, no COUPÈ, no M Sport	06026/1VM	390L, 390X, 3K, 3L	09/05	11	x	i	VM	1800	75	10,40	337,08	x		
3 SERIES TOURING	ESTATE F31, M Sport	06033/F	3L, 3K	12	08/19	x		F	1800	95	10,20	171,72	x		
3 SERIES TOURING	ESTATE F31, M Sport	06033/C	3L, 3K	12	08/19	x		C	1800	95	10,20	276,66	x		
3 SERIES TOURING	ESTATE F31, M Sport	06033/VM	3L, 3K	12	08/19	x		VM	1800	95	10,20	355,10	x		
3 SERIES TOURING	ESTATE G21, no M3, M Sport type bumper	06037/F	G3K	09/19		x	i	F	2222	90	12,00	174,90	x		
3 SERIES TOURING	ESTATE G21, no M3, M Sport type bumper	06037/C	G3K	09/19		x	i	C	2222	90	12,00	291,50	x		
3 SERIES TOURING	ESTATE G21, no M3, M Sport type bumper	06037/VM	G3K	09/19		x	i	VM	2222	90	12,00	371,00	x		
4 SERIES	COUPÉ	06033/F	1K, 3C, 3K, 3L	13	05/20	x		F	1800	95	10,20	171,72	x		
4 SERIES	COUPÉ	06033/C	1K, 3C, 3K, 3L	13	05/20	x		C	1800	95	10,20	276,66	x		
4 SERIES	COUPÉ	06033/VM	1K, 3C, 3K, 3L	13	05/20	x		VM	1800	95	10,20	355,10	x		
4 SERIES	COUPÉ, Pack M Sport	06037/F	G4C	06/20		x	i	F	2222	90	12,00	174,90	x		
4 SERIES	COUPÉ, Pack M Sport	06037/C	G4C	06/20		x	i	C	2222	90	12,00	291,50	x		
4 SERIES	COUPÉ, Pack M Sport	06037/VM	G4C	06/20		x	i	VM	2222	90	12,00	371,00	x		
4 SERIES	GRAN COUPÉ, Pack M Sport	06037/F	G4C	06/21		x	i	F	2222	90	12,00	174,90	x		
4 SERIES	GRAN COUPÉ, Pack M Sport	06037/C	G4C	06/21		x	i	C	2222	90	12,00	291,50	x		
4 SERIES	GRAN COUPÉ, Pack M Sport	06037/VM	G4C	06/21		x	i	VM	2222	90	12,00	371,00	x		
4 SERIES	COUPÉ, Pack M Sport, Hybrid	06042/F	G4C	06/20		x	i	F	2222	90	12,00	190,80	x		
4 SERIES	COUPÉ, Pack M Sport, Hybrid	06042/C	G4C	06/20		x	i	C	2222	90	12,00	280,90	x		















													
4 SERIES	COUPÉ, Pack M Sport, Hybrid	06042/VM	G4C	06/20		x	i	VM	2222	90	12,00	402,80	x
4 SERIES	GRAN COUPÉ, Pack M Sport, Hybrid	06042/F	G4C	06/21		x	i	F	2222	90	12,00	190,80	x
4 SERIES	GRAN COUPÉ, Pack M Sport, Hybrid	06042/C	G4C	06/21		x	i	C	2222	90	12,00	280,90	x
4 SERIES	GRAN COUPÉ, Pack M Sport, Hybrid	06042/VM	G4C	06/21		x	i	VM	2222	90	12,00	402,80	x
5 SERIES	Saloon E39	06019	5D	01/96	07/03	x	i	C	2075	90	11,20	321,18	x
5 SERIES	Saloon E39	06019/F	5D	01/96	07/03	x	i	F	2075	90	11,20	278,78	x
5 SERIES	Saloon E60, no M5, no M type bumper	06023/F	560L, 560X	07/03	10	x		F	2000	90	11,00	208,82	x
5 SERIES	Saloon E60, no M5, no M type bumper	06023/C	560L, 560X	07/03	10	x		C	2000	90	11,00	248,04	x
5 SERIES	Saloon E60, no M5, no M type bumper	06023/VM	560L, 560X	07/03	10	x		VM	2000	90	11,00	342,38	x
5 SERIES	Saloon F10, no M5, no M Sport type bumper	06031/F	5L	10	01/17	x		F	2000	90	11,70	195,04	x
5 SERIES	Saloon F10, no M5, no M Sport type bumper	06031/C	5L	10	01/17	x		C	2000	90	11,70	283,02	x
5 SERIES	Saloon F10, no M5, no M Sport type bumper	06031/VM	5L	10	01/17	x		VM	2000	90	11,70	360,40	x
5 SERIES	Saloon G30, no M5, M Sport type bumper	06037/F	G5L	02/17		x	i	F	2222	90	12,00	174,90	x
5 SERIES	Saloon G30, no M5, M Sport type bumper	06037/C	G5L	02/17		x	i	C	2222	90	12,00	291,50	x
5 SERIES	Saloon G30, no M5, M Sport type bumper	06037/VM	G5L	02/17		x	i	VM	2222	90	12,00	371,00	x
5 SERIES TOURING	ESTATE E39	06020	5D	03/97	03/04	x	i	C	2000	90	11,20	321,18	x
5 SERIES TOURING	ESTATE E61, no M5, no M type bumper	06023/F	560L, 560X	03/04	10	x		F	2000	90	11,00	208,82	x
5 SERIES TOURING	ESTATE E61, no M5, no M type bumper	06023/C	560L, 560X	03/04	10	x		C	2000	90	11,00	248,04	x
5 SERIES TOURING	ESTATE E61, no M5, no M type bumper	06023/VM	560L, 560X	03/04	10	x		VM	2000	90	11,00	342,38	x
5 SERIES TOURING	ESTATE F11, M Sport type bumper, no M5	06031/F	5K, 5L	10	02/17	x		F	2000	90	11,70	195,04	x
5 SERIES TOURING	ESTATE F11, M Sport type bumper, no M5	06031/C	5K, 5L	10	02/17	x		C	2000	90	11,70	283,02	x
5 SERIES TOURING	ESTATE F11, M Sport type bumper, no M5	06031/VM	5K, 5L	10	02/17	x		VM	2000	90	11,70	360,40	x
5 SERIES TOURING	ESTATE G31, no M5, M Sport type bumper	06037/F	G5K	03/17		x	i	F	2222	90	12,00	174,90	x
5 SERIES TOURING	ESTATE G31, no M5, M Sport type bumper	06037/C	G5K	03/17		x	i	C	2222	90	12,00	291,50	x
5 SERIES TOURING	ESTATE G31, no M5, M Sport type bumper	06037/VM	G5K	03/17		x	i	VM	2222	90	12,00	371,00	x
ACTIVE TOURER	MPV 5 seats, AdBlue, no Hybrid	06036/F	UKL-L, F2	09/14	09/21	x		F	2086	80	10,70	169,60	x
ACTIVE TOURER	MPV 5 seats, AdBlue, no Hybrid	06036/C	UKL-L, F2	09/14	09/21	x		C	2086	80	10,70	286,20	x
ACTIVE TOURER	MPV 5 seats, AdBlue, no Hybrid	06036/VM	UKL-L, F2	09/14	09/21	x		VM	2086	80	10,70	355,10	x
GRAN TOURER	MPV 7 seats, AdBlue	06036/F	UKL-L, F2	05/15		x		F	2086	80	10,70	169,60	x
GRAN TOURER	MPV 7 seats, AdBlue	06036/C	UKL-L, F2	05/15		x		C	2086	80	10,70	286,20	x
GRAN TOURER	MPV 7 seats, AdBlue	06036/VM	UKL-L, F2	05/15		x		VM	2086	80	10,70	355,10	x
X1	SUV E84 2-4WD	06030/F	X1	10/09	09/15	x		F	2000	80	10,90	196,10	x
X1	SUV E84 2-4WD	06030/C	X1	10/09	09/15	x		C	2000	80	10,90	309,52	x
X1	SUV E84 2-4WD	06030/VM	X1	10/09	09/15	x		VM	2000	80	10,90	333,90	x
X1	2-4 WD	06036/F	UKL-L, F1X	10/15	06/22	x		F	2086	80	10,70	169,60	x
X1	2-4 WD	06036/C	UKL-L, F1X	10/15	06/22	x		C	2086	80	10,70	286,20	x
X1	2-4 WD	06036/VM	UKL-L, F1X	10/15	06/22	x		VM	2086	80	10,70	355,10	x
X2	2-4 WD, also for M sport bumper	06038/F	F2X	01/18		x		F	2086	80	10,70	167,48	x















													
X2	2-4 WD, also for M sport bumper	06038/C	F2X	01/18		x		C	2086	80	10,70	274,54	x
X2	2-4 WD, also for M sport bumper	06038/VM	F2X	01/18		x		VM	2086	80	10,70	355,10	x
X3	SUV E83 4WD Bumper cut according to the version	06025/F	X83	12/04	11/09	x		F	2000	80	11,30	208,82	x
X3	SUV E83 4WD Bumper cut according to the version	06025/C	X83	12/04	11/09	x		C	2000	80	11,30	309,52	x
X3	SUV E83 4WD Bumper cut according to the version	06025/VM	X83	12/04	11/09	x		VM	2000	80	11,30	354,04	x
X3	SUV F25 4WD, also for M sport bumper	06032/F	X3, G3X	12/09		x		F	2400	100	12,00	208,82	x
X3	SUV F25 4WD, also for M sport bumper	06032/C	X3, G3X	12/09		x		C	2400	100	12,00	307,40	x
X3	SUV F25 4WD, also for M sport bumper	06032/VM	X3, G3X	12/09		x		VM	2400	100	12,00	400,68	x
X3	HYBRID	06043/F	G3X	08/18		x		F	2400	100	12,00	233,20	x
X3	HYBRID	06043/C	G3X	08/18		x		C	2400	100	12,00	328,60	x
X3	HYBRID	06043/VM	G3X	08/18		x		VM	2400	100	12,00	418,70	x
X4	2-4WD, no M sport bumper	06032/F	X4	07/14	06/18	x	i	F	2400	100	12,00	208,82	x
X4	2-4WD, no M sport bumper	06032/C	X4	07/14	06/18	x	i	C	2400	100	12,00	307,40	x
X4	2-4WD, no M sport bumper	06032/VM	X4	07/14	06/18	x	i	VM	2400	100	12,00	400,68	x
X4	2-4WD, M sport bumper	06039/F	G4X	07/18		x		F	2400	100	12,00	195,04	x
X4	2-4WD, M sport bumper	06039/C	G4X	07/18		x		C	2400	100	12,00	307,40	x
X4	2-4WD, M sport bumper	06039/VM	G4X	07/18		x		VM	2400	100	12,00	400,68	x
X5	SUV E70 4WD, also for M bumper	06028/F	X70, ZW, KS, LS	03/07	13	x	i	F	3500	140	16,30	220,48	x
X5	SUV E70 4WD, also for M bumper	06028/VM	X70, ZW, KS, LS	03/07	13	x	i	VM	3500	140	16,30	413,40	x
X5	SUV F15 4WD	06028/F	X70, ZW, KS, LS	13	08/18	x		F	3500	140	16,30	220,48	x
X5	SUV F15 4WD	06028/VM	X70, ZW, KS, LS	13	08/18	x		VM	3500	140	16,30	413,40	x
X6	SUV E71 4WD, to avoid cutting the bumper buy original spoiler BMW 51127192733 - BMW 51127192879	06029/F	X70, X6	05/08	11/14	x	v	F	3500	140	16,30	220,48	x
X6	SUV E71 4WD, to avoid cutting the bumper buy original spoiler BMW 51127192733 - BMW 51127192879	06029	X70, X6	05/08	11/14	x	v	VM	3500	140	16,30	413,40	x
X6	SUV F16 4WD, M, M Sport	06028/F	X70, ZW,KV	12/14	07/19	x		F	3500	140	16,30	220,48	x
X6	SUV F16 4WD, M, M Sport	06028/VM	X70, ZW,KV	12/14	07/19	x		VM	3500	140	16,30	413,40	x
X5	SUV G05 4WD, M Sport	06040/F	G5X	09/18		x		F	3559	150	16,00	206,70	x
X5	SUV G05 4WD, M Sport	06040/C	G5X	09/18		x		C	3559	150	16,00	296,80	x
X5	SUV G05 4WD, M Sport	06040/VM	G5X	09/18		x		VM	3559	150	16,00	355,10	x
X6	SUV G06 4WD, M Sport	06040/F	G6X	08/19		x		F	3559	150	16,00	206,70	x
X6	SUV G06 4WD, M Sport	06040/C	G6X	08/19		x		C	3559	150	16,00	296,80	x
X6	SUV G06 4WD, M Sport	06040/VM	G6X	08/19		x		VM	3559	150	16,00	355,10	x
X7	SUV G07 4WD, M Sport	06040/F	G7X	03/19		x		F	3559	150	16,00	206,70	x
X7	SUV G07 4WD, M Sport	06040/C	G7X	03/19		x		C	3559	150	16,00	296,80	x
X7	SUV G07 4WD, M Sport	06040/VM	G7X	03/19		x		VM	3559	150	16,00	355,10	x
X7	SUV G07, HYBRID	06041/F	G7X	03/19		x		F	3559	150	16,00	254,40	x
X7	SUV G07, HYBRID	06041/C	G7X	03/19		x		C	3559	150	16,00	339,20	x
X7	SUV G07, HYBRID	06041/VM	G7X	03/19		x		VM	3559	150	16,00	418,70	x
CHEVROLET													
AVEO	HATCHBACK 3-5 doors	07103/F	KLAS, CHIK, CHIA	06/08	05/11	x	i	F	1100	50	7,00	181,26	x
AVEO	HATCHBACK 3-5 doors	07103/C	KLAS, CHIK, CHIA	06/08	05/11	x	i	C	1100	50	7,00	279,84	x













													
AVEO	HATCHBACK 3-5 doors	07107/F	KL1T, CHIV	06/11		x	i	F	1100	75	7,00	166,42	x
AVEO	HATCHBACK 3-5 doors	07107/C	KL1T, CHIV	06/11		x	i	C	1100	75	7,00	275,60	x
AVEO	HATCHBACK 3-5 doors	07107/VM	KL1T, CHIV	06/11		x	i	VM	1100	75	7,00	355,10	x
CAPTIVA	SUV 2-4WD	07104/F	K LAC, CHIC, CAPTIVA VAN	02/06		x	v	F	2000	80	11,30	220,48	x
CAPTIVA	SUV 2-4WD	07104/C	K LAC, CHIC, CAPTIVA VAN	02/06		x	v	C	2000	80	11,30	331,78	x
CAPTIVA	SUV 2-4WD	07104/VM	K LAC, CHIC, CAPTIVA VAN	02/06		x	v	VM	2000	80	11,30	376,30	x
CRUZE	HATCHBACK 5 doors	28059/F	KL1J, CHIR	09/11		x	i	F	1200	75	9,00	184,44	x
CRUZE	HATCHBACK 5 doors	28059/C	KL1J, CHIR	09/11		x	i	C	1200	75	9,00	270,30	x
CRUZE	HATCHBACK 5 doors	28059/VM	KL1J, CHIR	09/11		x	i	VM	1200	75	9,00	318,00	x
CRUZE	Saloon 4 doors	28059/F	KL1J, CHIR	06/09		x	i	F	1200	75	9,00	184,44	x
CRUZE	Saloon 4 doors	28059/C	KL1J, CHIR	06/09		x	i	C	1200	75	9,00	270,30	x
CRUZE	Saloon 4 doors	28059/VM	KL1J, CHIR	06/09		x	i	VM	1200	75	9,00	318,00	x
CRUZE	ESTATE	07108/F	KL1J	06/12		x	i	F	1200	75	9,80	181,26	x
CRUZE	ESTATE	07108/C	KL1J	06/12		x	i	C	1200	75	9,80	299,98	x
CRUZE	ESTATE	07108/VM	KL1J	06/12		x	i	VM	1200	75	9,80	342,38	x
KALOS	HATCHBACK 5 doors	07103/C	KLAS, CHIK, CHIA	09/02	08	x	i	C	1100	50	7,00	279,84	x
KALOS	HATCHBACK 5 doors	07103/F	KLAS, CHIK, CHIA	09/02	8	x	i	F	1100	50	7,00	181,26	x
MATIZ	HATCHBACK 5 doors 800 CC EXCLUDED, Vehicle not suitable for towing	07105/F	CHIM, KLAJ	01/05		x	i	F	600	45	4,60	220,48	x
MATIZ	HATCHBACK 5 doors 800 CC EXCLUDED, Vehicle not suitable for towing	07105/C	CHIM, KLAJ	01/05		x	i	C	600	45	4,60	337,08	x
ORLANDO	MPV	07106/F	KL1Y, CHIO	02/11		x		F	1500	75	10,00	178,08	x
ORLANDO	MPV	07106/C	KL1Y, CHIO	02/11		x		C	1500	75	10,00	283,02	x
ORLANDO	MPV	07106/VM	KL1Y, CHIO	02/11		x		VM	1500	75	10,00	339,20	x
TACUMA	MPV	07101	KLAU	01/00				C	1500	75	9,00	319,06	x
TRAX	SUV 2-4WD	28064/F	KL1	02/13	06/19	x	v	F	1694	90	8,75	179,14	x
TRAX	SUV 2-4WD	28064/C	KL1	02/13	06/19	x	v	C	1694	90	8,75	284,08	x
TRAX	SUV 2-4WD	28064/VM	KL1	02/13	06/19	x	v	VM	1694	90	8,75	349,80	x
CHRYSLER													
300C	Saloon	21041/F	LX	04	11	x	i	F	2121	100	11,20	215,18	x
300C	Saloon	21041/C	LX	04	11	x	i	C	2121	100	11,20	319,06	x
300C	Saloon	21041/VM	LX	04	11	x	i	VM	2121	100	11,20	360,40	x
GRAND VOYAGER	MPV, no 4X4, L=4.733, 5.070	06052	GS	01/96	01/01			C	1600	80	10,40	198,22	x
GRAND VOYAGER	MPV L=5.096, no STOW'N GO	06053	RG	01	05		i	C	1600	80	10,80	322,24	x
GRAND VOYAGER	MPV L=5.096, no STOW'N GO	06053/F	RG	01	05		i	F	1600	80	10,80	209,88	x
GRAND VOYAGER	MPV STOW'N GO L=5.096 and 5.143, the seats in third row are retractable	06055/F	RG, RT	01/05		x	i	F	1600	100	10,20	184,44	x
GRAND VOYAGER	MPV STOW'N GO L=5.096 and 5.143, the seats in third row are retractable	06055/C	RG, RT	01/05		x	i	C	1600	100	10,20	288,32	x
GRAND VOYAGER	MPV STOW'N GO L=5.096 and 5.143, the seats in third row are retractable	06055/VM	RG, RT	01/05		x	i	VM	1600	100	10,20	361,46	x
PT CRUISER	MPV, CABRIO	06054	PT	00	10			C	1000	78	7,70	316,94	x
VOYAGER	MPV, no 4X4, L=4.733, 5.070	06052	GS	01/96	01/01			C	1600	80	10,40	198,22	x















														
VOYAGER	MPV L=4.808	06053/F	RG	01/02			i	F	1600	80	10,80	209,88	x	
VOYAGER	MPV L=4.808	06053	RG	01/02			i	C	1600	80	10,80	322,24	x	
CITROËN														
BERLINGO	MPV, no CHASSIS VERSION	07045/F	5, G, M	01/96	03/08		i	F	1100	70	7,50	178,08	x	
BERLINGO	MPV, no CHASSIS VERSION	07045/C	5, G, M	01/96	03/08		i	C	1100	70	7,50	299,98	x	
BERLINGO	MPV L=4.380, to open the doors of the version with double rear opening the trailer needs to be detached	07052/F	7	04/08	07/18			F	1504	75	8,90	184,44		x
BERLINGO	MPV L=4.380, to open the doors of the version with double rear opening the trailer needs to be detached	07052/C	7	04/08	07/18			C	1504	75	8,90	237,44		x
BERLINGO	MPV L=4.380, to open the doors of the version with double rear opening the trailer needs to be detached	07052/VM	7	04/08	07/18			VM	1504	75	8,90	332,84		x
BERLINGO	SIZE M MPV L=4.400, to open the doors of the version with double rear opening the trailer needs to be detached	07052/F	E	08/18				F	1504	75	8,90	184,44		x
BERLINGO	SIZE M MPV L=4.400, to open the doors of the version with double rear opening the trailer needs to be detached	07052/C	E	08/18				C	1504	75	8,90	237,44		x
BERLINGO	SIZE M MPV L=4.400, to open the doors of the version with double rear opening the trailer needs to be detached	07052/VM	E	08/18				VM	1504	75	8,90	332,84		x
BERLINGO	L2 MPV L=4.628, to open the doors of the version with double rear opening the trailer needs to be detached	07053/F	7	04/08	07/18			F	1504	75	8,90	184,44		x
BERLINGO	L2 MPV L=4.628, to open the doors of the version with double rear opening the trailer needs to be detached	07053/C	7	04/08	07/18			C	1504	75	8,90	237,44		x
BERLINGO	L2 MPV L=4.628, to open the doors of the version with double rear opening the trailer needs to be detached	07053/VM	7	04/08	07/18			VM	1504	75	8,90	332,84		x
BERLINGO	SIZE M MPV L=4.753, to open the doors of the version with double rear opening the trailer needs to be detached	07053/F	E	08/18				F	1504	75	8,90	184,44		x
BERLINGO	SIZE XL MPV L=4.753, to open the doors of the version with double rear opening the trailer needs to be detached	07053/C	E	08/18				C	1504	75	8,90	237,44		x
BERLINGO	SIZE XL MPV L=4.753, to open the doors of the version with double rear opening the trailer needs to be detached	07053/VM	E	08/18				VM	1504	75	8,90	332,84		x
C-CROSSER	SUV	24018/F	V	07/07			i	F	2000	100	11,00	256,52		x
C-CROSSER	SUV	24018/C	V	07/07			i	C	2000	100	11,00	336,02		x
C2	HATCHBACK 3 doors	29040/F	JM	01/02		x		F	565	70	7,00	196,10		x
C2	HATCHBACK 3 doors	29040/C	JM	01/02		x		C	565	70	7,00	267,12		x
C2	HATCHBACK 3 doors	29040/VM	JM	01/02		x		VM	565	70	7,00	360,40		x
C3	HATCHBACK 5 doors, no PLURIEL	07040/F	FC, FL, FR, SA, SC	01/02	12/09	x		F	1176	60	7,00	196,10		x
C3	HATCHBACK 5 doors, no PLURIEL	07040/C	FC, FL, FR, SA, SC	01/02	12/09	x		C	1176	60	7,00	267,12		x
C3	HATCHBACK 5 doors, no PLURIEL	07040/VM	FC, FL, FR, SA, SC	01/02	12/09	x		VM	1176	60	7,00	360,40		x















													
C3 II	NEW C3, no PLURIEL	07040/F	FC, FL, FR, SA, SC	01/10	06/16	x		F	1176	60	7,00	196,10	x
C3 II	NEW C3, no PLURIEL	07040/C	FC, FL, FR, SA, SC	01/10	06/16	x		C	1176	60	7,00	267,12	x
C3 II	NEW C3, no PLURIEL	07040/VM	FC, FL, FR, SA, SC	01/10	06/16	x		VM	1176	60	7,00	360,40	x
C3 III	HATCHBACK	07050/F	S	07/16		x		F	1450	80	7,70	184,44	x
C3 III	HATCHBACK	07050/C	S	07/16		x		C	1450	80	7,70	268,18	x
C3 III	HATCHBACK	07050/VM	S	07/16		x		VM	1450	80	7,70	338,14	x
C3 AIRCROSS	SUV, AdBlue, check if it is possible to tow	28066/F	P7, 2 C, 2 R	03/17		x	i	F	962	65	6,20	186,56	x
C3 AIRCROSS	SUV, AdBlue, check if it is possible to tow	28066/C	P7, 2 C, 2 R	03/17		x	v	C	962	65	6,20	297,86	x
C3 AIRCROSS	SUV, AdBlue, check if it is possible to tow	28066/VM	P7, 2 C, 2 R	03/17		x	i	VM	962	65	6,20	358,28	x
C3 PICASSO	MPV	07050/F	SH	02/09		x	i	F	1450	80	7,70	184,44	x
C3 PICASSO	MPV	07050/C	SH	02/09		x	i	C	1450	80	7,70	268,18	x
C3 PICASSO	MPV	07050/VM	SH	02/09		x	i	VM	1450	80	7,70	338,14	x
C3 X-TR	SUV	07040/F	FC, FL, FR, SA, SC	01/04		x		F	1176	60	7,00	196,10	x
C3 X-TR	SUV	07040/C	FC, FL, FR, SA, SC	01/04		x		C	1176	60	7,00	267,12	x
C3 X-TR	SUV	07040/VM	FC, FL, FR, SA, SC	01/04		x		VM	1176	60	7,00	360,40	x
C4	HATCHBACK 5 doors, COUPÈ	07039/F	LC, LA, LR	10/04	11/10	x	i	F	1811	73	9,30	196,10	x
C4	HATCHBACK 5 doors, COUPÈ	07039/C	LC, LA, LR	10/04	11/10	x	i	C	1811	73	9,30	288,32	x
C4	HATCHBACK 5 doors, COUPÈ	07039/VM	LC, LA, LR	10/04	11/10	x	i	VM	1811	73	9,30	361,46	x
C4	HATCHBACK 5 doors, LPG VERSION	07039/2F	N NC, N NX	12/10	12/19	x	i	F	1650	75	9,30	196,10	x
C4	HATCHBACK 5 doors, LPG VERSION	07039/2C	NNC, N NX	12/10	12/19	x	i	C	1650	75	9,30	288,32	x
C4	HATCHBACK 5 doors, LPG VERSION	07039/2VM	NNC, N NX	12/10	12/19	x	i	VM	1650	75	9,30	361,46	x
C4 AIRCROSS	SUV 2-4WD	24020/F	BU	05/12		x	i	F	1400	70	8,60	196,10	x
C4 AIRCROSS	SUV 2-4WD	24020/C	BU	05/12		x	i	C	1400	70	8,60	275,60	x
C4 AIRCROSS	SUV 2-4WD	24020/VM	BU	05/12		x	i	VM	1400	70	8,60	361,46	x
C4 CACTUS	2WD, while stock lasts	07048/F	O	09/14		x		F	1419	55	7,40	186,56	x
C4 CACTUS	2WD, while stock lasts	07048/C	O	09/14		x		C	1419	55	7,40	291,50	x
C4 CACTUS	2WD, while stock lasts	07048/VM	O	09/14		x		VM	1419	55	7,40	365,70	x
C4 CACTUS	HATCHBACK	07050/F	O	09/14		x	i	F	1450	80	7,70	184,44	x
C4 CACTUS	HATCHBACK	07050/C	O	09/14		x	i	C	1450	80	7,70	268,18	x
C4 CACTUS	HATCHBACK	07050/VM	O	09/14		x	i	VM	1450	80	7,70	338,14	x
C4 GRAND PICASSO	MPV 5-7 seats	07047/F	3E, 3A	10/13	03/18	x	i	F	1700	70	9,80	202,46	x
C4 GRAND PICASSO	MPV 5-7 seats	07047/C	3E, 3A	10/13	03/18	x	v	C	1700	70	9,80	296,80	x
C4 GRAND PICASSO	MPV 5-7 seats	07047/VM	3E, 3A	10/13	03/18	x	i	VM	1700	70	9,80	371,00	x
GRAND C4 SPACETOURER	MPV 5-7 seats	07047/F	3E, 3A	04/18		x	i	F	1700	70	9,80	202,46	x
GRAND C4 SPACETOURER	MPV 5-7 seats	07047/C	3E, 3A	04/18		x	v	C	1700	70	9,80	296,80	x
GRAND C4 SPACETOURER	MPV 5-7 seats	07047/VM	3E, 3A	04/18		x	i	VM	1700	70	9,80	371,00	x
C4 PICASSO	MPV 7 seats	07041/F	UA, UD, UE, UU	10/06	09/13	x		F	1500	70	9,50	226,84	x
C4 PICASSO	MPV 7 seats	07041/C	UA, UD, UE, UU	10/06	09/13	x		C	1500	70	9,50	298,92	x



													
C4 PICASSO	MPV 7 seats	07041/VM	UA, UD, UE, UU	10/06	09/13	x		VM	1500	70	9,50	355,10	x
C4 PICASSO	MPV 5 seats	07051/F	UA, UD, UE, UU	10/06	09/13			F	1723	75	9,70	251,22	x
C4 PICASSO	MPV 5 seats	07051/C	UA, UD, UE, UU	10/06	09/13			C	1723	75	9,70	339,20	x
C4 PICASSO	MPV 5 seats	07051/VM	UA, UD, UE, UU	10/06	09/13			VM	1723	75	9,70	402,80	x
C4 PICASSO	MPV 5 seats	07047/F	3D	10/13	03/18	x	v	F	1700	70	9,80	202,46	x
C4 PICASSO	MPV 5 seats	07047/C	3D	10/13	03/18	x	v	C	1700	70	9,80	296,80	x
C4 PICASSO	MPV 5 seats	07047/VM	3D	10/13	03/18	x	v	VM	1700	70	9,80	371,00	x
C4 SPACETOURER	MPV 5 seats	07047/F	3D	04/18		x	v	F	1700	70	9,80	202,46	x
C4 SPACETOURER	MPV 5 seats	07047/C	3D	04/18		x	v	C	1700	70	9,80	296,80	x
C4 SPACETOURER	MPV 5 seats	07047/VM	3D	04/18		x	v	VM	1700	70	9,80	371,00	x
C5	HATCHBACK 5 doors	07036/F	DC	01/01	08/04			F	1600	75	9,30	209,88	x
C5	HATCHBACK 5 doors	07036/C	DC	01/01	08/04			C	1600	75	9,30	288,32	x
C5	Saloon	07042/CF	RD	08/08		x	i	F	1800	75	10,80	233,20	x
C5	Saloon	07042/CC	RD	08/08		x	i	C	1800	75	10,80	301,04	x
C5	Saloon	07042/CVM	RD	08/08		x	i	VM	1800	75	10,80	355,10	x
C5 BREAK	ESTATE	07035/C	DE, RE	01/01	07/08			C	1600	75	9,50	189,74	x
C5 TOURER	ESTATE, no double exhaust pipe	07043/F	RW	08/08		x	i	F	1800	75	10,80	215,18	x
C5 TOURER	ESTATE, no double exhaust pipe	07043/C	RW	08/08		x	i	C	1800	75	10,80	301,04	x
C5 TOURER	ESTATE, no double exhaust pipe	07043/VM	RW	08/08		x	i	VM	1800	75	10,80	355,10	x
C5 AIRCROSS	2-4WD, AdBlue, no Hybrid, no model with parking sensors	29052/F	A C, A J	01/19		x	v	F	2222	80	10,30	147,34	x
C5 AIRCROSS	2-4WD, AdBlue, no Hybrid	29052/C	A C, A J	01/19		x	v	C	2222	80	10,30	267,12	x
C5 AIRCROSS	2-4WD, AdBlue, no Hybrid	29052/VM	A C, A J	01/19		x	v	VM	2222	80	10,30	350,86	x
C5 AIRCROSS	HYBRID	28069/F	A	08/20		x	v	F	1322	70	8,30	243,80	x
C5 AIRCROSS	HYBRID	28069/C	A	08/20		x	v	C	1322	70	8,30	307,40	x
C5 AIRCROSS	HYBRID	28069/VM	A	08/20		x	v	VM	1322	70	8,30	365,70	x
C8	MPV	13137/F	EA, EB	03/02				F	1850	76	11,00	209,88	x
C8	MPV	13137/C	EA, EB	03/02				C	1850	76	11,00	295,74	x
DS3	HATCHBACK 3 doors	07040/F	SA, SC	12/09		x	i	F	1150	60	7,00	196,10	x
DS3	HATCHBACK 3 doors	07040/C	SA, SC	12/09		x	i	C	1150	60	7,00	267,12	x
DS3	HATCHBACK 3 doors	07040/VM	SA, SC	12/09		x	i	VM	1150	60	7,00	360,40	x
DS 3 CROSSBACK	CROSSOVER	29053/F	U	6/19		x	i	F	1253	55	7,20	217,30	x
DS 3 CROSSBACK	CROSSOVER	29053/C	U	6/19		x	i	C	1253	55	7,20	294,68	x
DS 3 CROSSBACK	CROSSOVER	29053/VM	U	6/19		x	i	VM	1253	55	7,20	337,08	x
DS4	HATCHBACK 5 doors, no 1,6 THP, 200 cv	07039/1F	NN, NX	06/11		x		F	1650	75	9,30	190,80	x
DS4	HATCHBACK 5 doors, no 1,6 THP, 200 cv	07039/1C	NN, NX	06/11		x		C	1650	75	9,30	288,32	x
DS4	HATCHBACK 5 doors, no 1,6 THP, 200 cv	07039/1VM	NN, NX	06/11		x		VM	1650	75	9,30	361,46	x
DS5	HATCHBACK 5 doors, also Restyling 2015, no Hybrid4	07046/F	KK, K	04/12		x	i	F	1500	75	9,00	190,80	x
DS5	HATCHBACK 5 doors, also Restyling 2015, no Hybrid4	07046/C	KK, K	04/12		x	i	C	1500	75	9,00	307,40	x
DS5	HATCHBACK 5 doors, also Restyling 2015, no Hybrid4	07046/VM	KK, K	04/12		x	i	VM	1500	75	9,00	349,80	x
DYANE - AMI - 2CV	HATCHBACK, no MEHARI	07004				x		F	500			236,38	x
EVASION	MPV	13133/F	U6, A, B	09/94	03/02		v	F	1300	60	10,50	209,88	x
EVASION	MPV	13133	U6, A, B	09/94	03/02		v	C	1300	60	10,50	268,18	x

















														
JUMPER	PICK UP, check D value	13147/C	Y	06/06					C	3000	120	16,90	358,28	x
JUMPER	PICK UP, check D value	13147/G	Y	06/06					GRIFO	3000	120	16,90	552,26	x
JUMPER	VAN, PICK UP, model with parking sensors, 4X4	13148/1SF	23,Z	94	05/06				SF	2000	110	13,40	258,64	x
JUMPER	VAN, PICK UP, model with parking sensors, 4X4	13148/1G	23,Z	94	05/06				GRIFO	2000	110	13,40	521,52	x
JUMPER	VAN, PICK UP, model with parking sensors, no 4X4	13148/SF	23,Z	94	05/06				SF	2000	110	13,40	244,86	x
JUMPER	VAN, PICK UP, model with parking sensors, no 4X4	13148/G	23,Z	94	05/06				GRIFO	2000	110	13,40	509,86	x
JUMPER	VAN, model with parking sensors, check D value	13146	Y	06/06		x			C	3000	120	16,90	259,70	x
JUMPY	VAN	13133	U6, A, B	94	07		v		C	1300	60	10,50	268,18	x
JUMPY	VAN	13133/F	U6, A, B	94	07		v		F	1300	60	10,50	209,88	x
JUMPY	VAN, MINIBUS	13151/C	X	01/07	03/16	x	i		C	2000	80	12,50	324,36	x
JUMPY	VAN, MINIBUS	13151/F	X	01/07	03/16	x	i		F	2000	80	12,50	174,90	x
JUMPY	VAN	07049/F	V	04/16		x			F	2644	120	14,00	181,26	x
JUMPY	VAN	07049/C	V	04/16		x			C	2644	120	14,00	254,40	x
NEMO	No Natural Power	13152/F	AA, AJ	02/08					F	1000	60	6,50	181,26	x
NEMO	No Natural Power	13152	AA, AJ	02/08					C	1000	60	6,50	235,32	x
SAXO	HATCHBACK 3-5 doors	07029	S	01/96	04/04		i		C	700	50	4,83	200,34	x
SPACE TOURER	MPV	07049/F	V	04/16		x			F	2644	120	14,00	181,26	x
SPACE TOURER	MPV	07049/C	V	04/16		x			C	2644	120	14,00	254,40	x
XSARA	HATCHBACK 3-5 doors, COUPÈ	07033/F	N1, N7, N10, N6, N0	98	12/00	x	v		F	1100	70	7,50	209,88	x
XSARA	HATCHBACK 3-5 doors, COUPÈ	07033	N1, N7, N10, N6, N0	98		x	v		C	1100	70	7,50	263,94	x
XSARA BREAK	ESTATE	07032	N2, N4	01/98					C	1100	70	7,50	286,20	x
XSARA PICASSO	MPV	07034/F	C	01/99		x	v		F	1300	80	8,00	174,90	x
XSARA PICASSO	MPV	07034	C	01/99		x	v		C	1300	80	8,00	296,80	x
ZX	HATCHBACK 3-5 doors	07022	N2	91		x	v		C	1100	77		236,38	x
CUPRA														
FORMENTOR	Suv coupé, 2-4WD, AdBlue	33023/F	KM	01/21		x			F	2575	100	12,20	163,24	x
FORMENTOR	Suv coupé, 2-4WD, AdBlue	33023/C	KM	01/21		x			C	2575	100	12,20	262,88	x
FORMENTOR	Suv coupé, 2-4WD, AdBlue	33023/VM	KM	01/21		x			VM	2575	100	12,20	318,00	x
DACIA														
DOKKER	MPV	08005/F	OS, 8S, 8E, 8D, 00	09/12					F	1200	75	7,50	184,44	x
DOKKER	MPV	08005/C	OS, 8S, 8E, 8D, 00	09/12					C	1200	75	7,50	294,68	x
DUSTER	SUV 2-4WD, restyling '14, restyling '17, Brave Edition, LPG, AdBlue	08007/F	HS, DH, HE	04/10			i		F	1500	75	8,70	171,72	x
DUSTER	SUV 2-4WD, restyling '14, restyling '17, Brave Edition, LPG, AdBlue	08007/C	HS, DH, HE	04/10			i		C	1500	75	8,70	270,30	x
DUSTER	SUV 2-4WD, restyling '14, restyling '17, Brave Edition, LPG, AdBlue	08007/VM	HS, DH, HE	04/10			i		VM	1500	75	8,70	333,90	x
JOGGER	MPV	08012/F	DJF	11/20 21		x			F	1440	75	7,70	210,00	x
JOGGER	MPV	08012/C	DJF	11/20 21		x			C	1440	75	7,70	295,00	x













													
JOGGER	MPV	08012/VM	DJF	11/20 21		x		VM	1440	75	7,70	365,00	x
LODGY	MPV 5-7 seats, LPG, AdBlue, check if it is possible to tow	08004/F	JS, JE, JD	10/12			i	F	1400	75	8,00	184,44	x
LODGY	MPV 5-7 seats, LPG, AdBlue, check if it is possible to tow	08004/C	JS, JE, JD	10/12			i	C	1400	75	8,00	294,68	x
LODGY	MPV 5-7 seats, LPG, AdBlue, check if it is possible to tow	08004/VM	JS, JE, JD	10/12			i	VM	1400	75	8,00	360,40	x
LODGY STEPWAY	MPV 5-7 seats, LPG, AdBlue, check if it is possible to tow	08004/F	JS, JE, JD	10/12			i	F	1400	75	8,00	184,44	x
LODGY STEPWAY	MPV 5-7 seats, LPG, AdBlue, check if it is possible to tow	08004/C	JS, JE, JD	10/12			i	C	1400	75	8,00	294,68	x
LODGY STEPWAY	MPV 5-7 seats, LPG, AdBlue, check if it is possible to tow	08004/VM	JS, JE, JD	10/12			i	VM	1400	75	8,00	360,40	x
LOGAN MCV	ESTATE, LPG VERSION	08002/F	KS, FS	01/07	13		i	F	1300	75	7,90	206,70	x
LOGAN MCV	ESTATE, LPG VERSION	08002/C	KS, FS	01/07	13		i	C	1300	75	7,90	320,12	x
LOGAN MCV	ESTATE, LPG VERSION	08002/VM	KS, FS	01/07	13		i	VM	1300	75	7,90	355,10	x
LOGAN MCV	ESTATE	08008/F	7S, 7E, 7D	13	10/20			F	1633	75	8,10	196,10	x
LOGAN MCV	ESTATE	08008/C	7S, 7E, 7D	13	10/20			C	1633	75	8,10	294,68	x
LOGAN MCV	ESTATE	08008/VM	7S, 7E, 7D	13	10/20			VM	1633	75	8,10	339,20	x
LOGAN	Saloon	08010/F	LS	01/04	12/12			F	1134	75	6,40	201,40	x
LOGAN	Saloon	08010/C	LS	01/04	12/12			C	1134	75	6,40	259,70	x
LOGAN	Saloon	08011/F	L8, SD	01/13	12/20			F	1281	75	6,80	201,40	x
LOGAN	Saloon	08011/C	L8, SD	01/13	12/20			C	1281	75	6,80	259,70	x
SANDERO	HATCHBACK 5 doors, LPG VERSION	08001/F	BS	06/08	09/12	x		F	1100	75	6,70	222,60	x
SANDERO	HATCHBACK 5 doors, LPG VERSION	08001/C	BS	06/08	09/12	x		C	1100	75	6,70	254,40	x
SANDERO	HATCHBACK 5 doors, LPG VERSION	08006/F	BS, 5S, 5E, 5D	10/12	12/20	x	i	F	1100	75	6,70	202,46	x
SANDERO	HATCHBACK 5 doors, LPG VERSION	08006/C	BS, 5S, 5E, 5D	10/12	12/20	x	i	C	1100	75	6,70	254,40	x
SANDERO STEPWAY	HATCHBACK 5 doors, LPG VERSION	08001/F	BS	07/08	12/12	x		F	1100	75	6,70	222,60	x
SANDERO STEPWAY	HATCHBACK 5 doors, LPG VERSION	08001/C	BS	07/08	12/12	x		C	1100	75	6,70	254,40	x
SANDERO STEPWAY	HATCHBACK 5 doors, LPG VERSION	08006/F	BS, 5S, 5E, 5D	10/12	12/20	x	i	F	1100	75	6,70	202,46	x
SANDERO STEPWAY	HATCHBACK 5 doors, LPG VERSION	08006/C	BS, 5S, 5E, 5D	10/12	12/20	x	i	C	1100	75	6,70	254,40	x
SANDERO	HATCHBACK 5 doors, B/GPL	31112/F	BE	01/21		x	i	F	1303	75	7,60	204,58	x
SANDERO	HATCHBACK 5 doors, B/GPL	31112/C	BE	01/21		x	i	C	1303	75	7,60	262,88	x
SANDERO	HATCHBACK 5 doors, B/GPL	31112/VM	BE	01/21		x	i	VM	1303	75	7,60	337,08	x
SANDERO STEPWAY	HATCHBACK 5 doors, B/GPL	31112/F	5E	01/21		x	i	F	1303	75	7,60	204,58	x
SANDERO STEPWAY	HATCHBACK 5 doors, B/GPL	31112/C	5E	01/21		x	i	C	1303	75	7,60	262,88	x
SANDERO STEPWAY	HATCHBACK 5 doors, B/GPL	31112/VM	5E	01/21		x	i	VM	1303	75	7,60	337,08	x
DAIHATSU													
BERTONE	FREE KLIMBER II, ROCKY AMERICA 4WD, FERENZA 4WD with circular rear cross beam	09004	186	92				C	1300	91		230,02	x
FERENZA	FERENZA BERTONE 4WD without circular rear cross beam	09003	F300, 184	92				C	1700	98		230,02	x
TERIOS	SUV 4WD, no LPG, no petrol/LPG	09005	J100, J102, J12, J122	01/97	03/06			C	1400	60	8,00	339,20	x
TERIOS	SUV 4WD, no LPG	09006/F	J2	04/06				F	1350	55	8,00	186,56	x
TERIOS	SUV 4WD, no LPG	09006/C	J2	04/06				C	1350	55	8,50	341,32	x















														
DODGE														
CALIBER	CROSSOVER SUV	10001/F	PK	03/06	10			F	1500	80	9,20	171,72		x
CALIBER	CROSSOVER SUV	10001/C	PK	03/06	10			C	1500	80	9,20	260,76		x
CALIBER	CROSSOVER SUV	10001/VM	PK	03/06	10			VM	1500	80	9,20	354,04		x
JOURNEY	CROSSOVER SUV with spare wheel under the panel	13158/F	JC	06/08		x	v	F	1100	80	10,50	190,80		x
JOURNEY	CROSSOVER SUV with spare wheel under the panel	13158/C	JC	06/08		x	v	C	1100	80	10,50	275,60		x
JOURNEY	CROSSOVER SUV with spare wheel under the panel	13158/VM	JC	06/08		x	v	VM	1100	80	10,50	368,88		x
JOURNEY	CROSSOVER SUV without spare wheel under the panel	10003/F	JC	06/08		x		F	1600	80	10,50	184,44		x
JOURNEY	CROSSOVER SUV without spare wheel under the panel	10003/C	JC	06/08		x		C	1600	80	10,50	275,60		x
JOURNEY	CROSSOVER SUV without spare wheel under the panel	10003/VM	JC	06/08		x		VM	1600	80	10,50	368,88		x
NITRO	SUV 2-4WD	10002/C	KJ	06/07		x	i	C	3500	140	15,20	337,08		x
NITRO	SUV 2-4WD	10002/SF	KJ	06/07		x	i	SF	3500	140	15,20	280,90		x
NITRO	SUV 2-4WD	10002/G	KJ	06/07		x	i	GRIFO	3500	140	15,20	523,64		x
DR														
DR 4.0	2WD	10052/F	T3X, T39	10/21		x	i	F	1052	70	6,50	206,70		x
DR 4.0	2WD	10052/C	T3X, T39	10/21		x	i	C	1052	70	6,50	273,48		x
DR 4.0	2WD	10052/VM	T3X, T39	10/21		x	i	VM	1052	70	6,50	376,30		x
DR5	2-4WD, Bifuel, Evo, Special, the towball has to be removed to open the rear door	39021/D	D3	07				C	1800	75	9,50	261,82		x
DR 5.0	2WD	10052/F	T3X, T39	01/20		x	i	F	1052	70	6,50	206,70		x
DR 5.0	2WD	10052/C	T3X, T39	01/20		x	i	C	1052	70	6,50	273,48		x
DR 5.0	2WD	10052/VM	T3X, T39	01/20		x	i	VM	1052	70	6,50	376,30		x
DR6	2WD	10051/F	D3	01/19		x	i	F	1191	70	7,20	238,50		x
DR6	2WD	10051/C	D3	01/19		x	i	C	1191	70	7,20	302,10		x
DR6	2WD	10051/VM	D3	01/19		x	i	VM	1191	70	7,20	386,90		x
EVO CROSS4	PICK-UP	10054/F	T8	01/22				F	2865	140	12,00	328,60		x
EVO CROSS4	PICK-UP	10054/C	T8	01/22				C	2865	140	12,00	397,50		x
EVO CROSS4	PICK-UP	10054/SF	T8	01/22				SF(C)	2865	140	12,00	355,10		x
EVO CROSS4	PICK-UP	10054/G	T8	01/22				GRIFO(C)	2865	140	12,00	519,40		x
EVO CROSS4	PICK-UP	10054/SFM	T8	01/22				SFM(C)	2865	140	12,00	625,40		x
F35	2WD	10053/F	T3X, T35	01/20		x	i	F	1043	70	6,50	206,70		x
F35	2WD	10053/C	T3X, T35	01/20		x	i	C	1043	70	6,50	273,48		x
F35	2WD	10053/VM	T3X, T35	01/20		x	i	VM	1043	70	6,50	376,30		x
6.0	2WD	10053/F	T3X, T35	01/21		x	i	F	1043	70	6,50	206,70		x
6.0	2WD	10053/C	T3X, T35	01/21		x	i	C	1043	70	6,50	273,48		x
6.0	2WD	10053/VM	T3X, T35	01/21		x	i	VM	1043	70	6,50	376,30		x
SPORTEQUIPE PK8	PICK-UP	10054/F	T8	01/22				F	2865	140	12,00	328,60		x
SPORTEQUIPE PK8	PICK-UP	10054/C	T8	01/22				C	2865	140	12,00	397,50		x
SPORTEQUIPE PK8	PICK-UP	10054/SF	T8	01/22				SF(C)	2865	140	12,00	355,10		x
SPORTEQUIPE PK8	PICK-UP	10054/G	T8	01/22				GRIFO(C)	2865	140	12,00	519,40		x
SPORTEQUIPE PK8	PICK-UP	10054/SFM	T8	01/22				SFM(C)	2865	140	12,00	625,40		x















														
EVO														
6	2WD	10051/F	DR6	01/19		x	i	F	1191	70	7,20	238,50		x
6	2WD	10051/C	DR6	01/19		x	i	C	1191	70	7,20	302,10		x
6	2WD	10051/VM	DR6	01/19		x	i	VM	1191	70	7,20	386,90		x
DS														
DS 7 CROSSBACK	SUV	10151/F	J 4, J C	02/18		x	i	F	1931	80	10,50	233,20		x
DS 7 CROSSBACK	SUV	10151/C	J 4, J C	02/18		x	i	C	1931	80	10,50	307,40		x
DS 7 CROSSBACK	SUV	10151/VM	J 4, J C	02/18		x	i	VM	1931	80	10,50	402,80		x
FIAT														
500	HATCHBACK 3 doors, 500 S, no LPG	13168/F	312	11/07		x	i	F	1137	60	6,30	146,28		x
500	HATCHBACK 3 doors, 500 S, no LPG	13168/C	312	11/07		x	i	C	1137	60	6,30	186,56		x
500	HATCHBACK 3 doors, 500 S, no LPG	13168/VM	312	11/07		x	i	VM	1137	60	6,30	338,14		x
500	Saloon	13004			00	x		DM	400			227,90	x	
500 ABARTH	HATCHBACK 3 doors	13169/F	312	01/08		x	v	F	1137	60	6,30	204,58		x
500 ABARTH	HATCHBACK 3 doors	13169/C	312	01/08		x	v	C	1137	60	6,30	303,16		x
500 ABARTH	HATCHBACK 3 doors	13169/VM	312	01/08		x	v	VM	1137	60	6,30	365,70		x
500L	MPV	13159/F	199	09/12	07/17	x	i	F	1200	85	7,50	220,48		x
500L	MPV	13159/C	199	09/12	07/17	x	i	C	1200	85	7,50	294,68		x
500L	MPV	13159/VM	199	09/12	07/17	x	i	VM	1200	85	7,50	356,16		x
500L	MPV	13161/F	199	08/17		x	i	F	1200	65	7,50	220,48		x
500L	MPV	13161/C	199	08/17		x	i	C	1200	65	7,50	294,68		x
500L	MPV	13161/VM	199	08/17		x	i	VM	1200	65	7,50	356,16		x
500L CROSS	MPV	13161/F	199	08/17		x	i	F	1200	65	7,50	220,48		x
500L CROSS	MPV	13161/C	199	08/17		x	i	C	1200	65	7,50	294,68		x
500L CROSS	MPV	13161/VM	199	08/17		x	i	VM	1200	65	7,50	356,16		x
500L LIVING	MPV	13159/F	199	09/13	07/17	x	i	F	1200	85	7,50	220,48		x
500L LIVING	MPV	13159/C	199	09/13	07/17	x	i	C	1200	85	7,50	294,68		x
500L LIVING	MPV	13159/VM	199	09/13	07/17	x	i	VM	1200	85	7,50	356,16		x
500L LIVING	MPV	13161/F	199	08/17		x	i	F	1200	65	7,50	220,48		x
500L LIVING	MPV	13161/C	199	08/17		x	i	C	1200	65	7,50	294,68		x
500L LIVING	MPV	13161/VM	199	08/17		x	i	VM	1200	65	7,50	356,16		x
500L TREKKING	MPV	13161/F	199	09/13		x	i	F	1200	65	7,50	220,48		x
500L TREKKING	MPV	13161/C	199	09/13		x	i	C	1200	65	7,50	294,68		x
500L TREKKING	MPV	13161/VM	199	09/13		x	i	VM	1200	65	7,50	356,16		x
500X	2-4WD, Cross, Cross Plus	19022/F	334	01/15		x	i	F	1641	100	10,10	177,02		x
500X	2-4WD, Cross, Cross Plus	19022/C	334	01/15		x	V	C	1641	100	10,10	292,56		x
500X	2-4WD, Cross, Cross Plus	19022/VM	334	01/15		x	i	VM	1641	100	10,10	362,52		x
500X	Sport	13171/F	334	11/19		x	i	F	1641	100	10,10	177,02		x
500X	Sport	13171/C	334	11/19		x	V	C	1641	100	10,10	292,56		x
500X	Sport	13171/VM	334	11/19		x	i	VM	1641	100	10,10	362,52		x
ALBEA	Saloon	13170/F	178	01/02	12/12			F	1468	70	6,90	245,00		x
ALBEA	Saloon	13170/C	178	01/02	12/12			C	1468	70	6,90	310,00		x
BRAVA	Saloon 5 doors	13121	182B,187	01/95	12/06	x		C	1300	70	7,50	239,56	x	
BRAVO	HATCHBACK 3 doors	13122	182	01/95	12/06	x		C	1300	70	7,66	241,68	x	
BRAVO	HATCHBACK 5 doors	13150/F	198	02/07		x	i	F	1300	60	8,30	166,42		x
BRAVO	HATCHBACK 5 doors	13150/C	198	02/07		x	i	C	1300	60	8,30	275,60		x















														
BRAVO	HATCHBACK 5 doors	13150/VM	198	02/07		x	i	VM	1300	60	8,30	365,70		x
CINQUECENTO	HATCHBACK	13124	170	01/92	03/98	x		C	400	28		198,22	x	
CROMA	ESTATE, Restyling '07	13143/F	194	06/05		x	i	F	1500	70	9,50	196,10		x
CROMA	ESTATE, Restyling '07	13143/C	194	06/05		x	i	C	1500	70	9,50	261,82		x
CROMA	ESTATE, Restyling '07	13143/VM	194	06/05		x	i	VM	1500	70	9,50	355,10		x
DAILY	VAN 29L-35S	13156/SF		99	06/14			SF	3500	140	20,70	217,30	x	
DAILY	VAN 29L-35S	13156/G		99	06/14			GRIFO	3500	140	20,70	521,52	x	
DAILY	CHASSIS CAB 35C	13156/1SF		99	06/14			SF	3500	140	20,70	217,30	x	
DAILY	CHASSIS CAB 35C	13156/1G		99	06/14			GRIFO	3500	140	20,70	521,52	x	
DAILY	VAN 35C-40C-45C-50C, wheelbase 3950	13156/1SF		99	06/14			SF	3500	140	20,70	217,30	x	
DAILY	VAN 35C-40C-45C-50C, wheelbase 3950	13156/1G		99	06/14			GRIFO	3500	140	20,70	521,52	x	
DAILY	VAN 30S-35S wheelbase 3.000-3.520, 35C wheelbase 3.520, not for VAN 30S-35S and 35C with wheelbase 3.520-4.100 and 4.100	13164/SF	IS30, IS35, IS35C	07/14				SF	4000	140	23,00	217,30		x
DAILY	VAN 30S-35S wheelbase 3.000-3.520, 35C wheelbase 3.520, not for VAN 30S-35S and 35C with wheelbase 3.520-4.100 and 4.100	13164/G	IS30, IS35, IS35C	07/14				GRIFO	4000	140	23,00	521,52		x
DAILY	VAN 30S-35S, wheelbase 3520L-4100, 35C wheelbase 3520L, 40C-50C wheelbase 3520L	13165/SF	IS30S, IS35S, IS35C, IS40C, IS	07/14				SF	3500	140	23,00	209,88		x
DAILY	VAN 30S-35S, wheelbase 3520L-4100, 35C wheelbase 3520L, 40C-50C wheelbase 3520L	13165/G	IS30S, IS35S, IS35C, IS40C, IS	07/14				GRIFO	3500	140	23,00	339,20		x
DOBLO'	MPV, Restyling '05, Natural Power	13163/F	223	11/00	02/10	x	i	F	1443	60	8,40	186,56		x
DOBLO'	MPV, Restyling '05, Natural Power	13163/C	223	11/00	02/10	x	i	C	1443	60	8,40	242,74		x
DOBLO'	MPV, Restyling '05, Natural Power	13163/VM	223	11/00	02/10	x	i	VM	1443	60	8,40	338,14		x
DOBLO'	MPV, Natural Power, no Trekking, no CHASSIS vehicles	13157/F	263	01/10	12/22	x	i	F	1500	60	9,70	174,90		x
DOBLO'	MPV, Natural Power, no Trekking, no CHASSIS vehicles	13157/C	263	01/10	12/22	x	i	C	1500	60	9,70	256,52		x
DOBLO'	MPV, Natural Power, no Trekking, no CHASSIS vehicles	13157/VM	263	01/10	12/22	x	i	VM	1500	60	9,70	338,14		x
DUCATO	VAN, PICK UP	13116	AR6, 280, 290	81	93			C	1500	105		200,34	x	
DUCATO	VAN, PICK UP model with parking sensors, 4X4	13148/1SF	230, 244	94	05/06			SF	2000	110	13,40	258,64	x	
DUCATO	VAN, PICK UP model with parking sensors, 4X4	13148/1G	230, 244	94	05/06			GRIFO	2000	110	13,40	521,52	x	
DUCATO	VAN, PICK UP model with parking sensors, no 4X4	13148/SF	230, 244	94	05/06			SF	2000	110	13,40	244,86	x	
DUCATO	VAN, PICK UP model with parking sensors, no 4X4	13148/G	230, 244	94	05/06			GRIFO	2000	110	13,40	509,86	x	
DUCATO	VAN, model with parking sensors	13146	250	06/06		x		C	3000	120	16,90	259,70		x
DUCATO	PICK UP	13147/C	250	06/06				C	3000	120	16,90	358,28		x
DUCATO	PICK UP	13147/G	250	06/06				GRIFO	3000	120	16,90	552,26		x
DUNA	PANORAMA	13074	146	87		x		C	1000	70		215,18	x	
FIORINO	If towball is fitted it is not possible to open the boot	13104		94			v	C	1100	77		191,86	x	
FIORINO	MPV, no Natural Power	13152/F	225	02/08				F	1000	60	6,50	181,26		x















															
FIORINO	MPV, no Natural Power	13152	225	02/08					C	1000	60	6,50	235,32		x
FREEMONT	MPV with spare wheel under the panel, AWD	13158/F	JC	06/11		x	v		F	1100	80	10,50	190,80		x
FREEMONT	MPV with spare wheel under the panel, AWD	13158/C	JC	06/11		x	v		C	1100	80	10,50	275,60		x
FREEMONT	MPV with spare wheel under the panel, AWD	13158/VM	JC	06/11		x	v		VM	1100	80	10,50	368,88		x
FREEMONT	MPV without spare wheel under the panel, AWD	10003/F	JC	06/11		x			F	1100	80	10,50	184,44		x
FREEMONT	MPV without spare wheel under the panel, AWD	10003/C	JC	06/11		x			C	1100	80	10,50	275,60		x
FREEMONT	MPV without spare wheel under the panel, AWD	10003/VM	JC	06/11		x			VM	1100	80	10,50	368,88		x
FULLBACK	4WD, Double Cab, Club Cab, with step bumper, tubular bumper	24022/F	KA0T, KJ0T, KT0T	06/16		x			F	3567	160	16,30	232,14	x	
FULLBACK	4WD, Double Cab, Club Cab, with step bumper, tubular bumper	24022/C	KA0T, KJ0T, KT0T	06/16		x			C	3567	160	16,30	324,36	x	
FULLBACK	4WD, Double Cab, Club Cab, with step bumper, tubular bumper	24022/SF	KA0T, KJ0T, KT0T	06/16		x			SF(C)	3567	160	16,30	265,00	x	
FULLBACK	4WD, Double Cab, Club Cab, with step bumper, tubular bumper	24022/G	KA0T, KJ0T, KT0T	06/16		x			GRIFO(C)	3567	160	16,30	339,20	x	
FULLBACK	4WD, Double Cab, Club Cab, with step bumper, tubular bumper	24022/SFM	KA0T, KJ0T, KT0T	06/16		x			SFM(C)	3567	160	16,30	434,60	x	
GRANDE PUNTO	HATCHBACK 3-5 doors, LPG, no Natural Power	13149/F	199	12/05		x	i		F	1000	75	7,50	171,72		x
GRANDE PUNTO	HATCHBACK 3-5 doors, LPG, no Natural Power	13149/C	199	12/05		x	i		C	1000	75	7,50	239,56		x
GRANDE PUNTO	HATCHBACK 3-5 doors, LPG, no Natural Power	13149/VM	199	12/05		x	i		VM	1000	75	7,50	338,14		x
IDEA	MPV	13166/F	350	12/03	07/14	x	v		F	1281	60	7,30	181,26		x
IDEA	MPV	13166/C	350	12/03	07/14	x	v		C	1281	60	7,30	224,72		x
IDEA	MPV, the housing is slightly visible	13166/VM	350	12/03	07/14	x	v		VM	1281	60	7,30	321,18		x
MAREA	Saloon	13119	185A	01/96		x	i		C	1400	70	8,25	227,90		x
MAREA MARENGO	VAN	13120	185B, 185C	01/96					C	1400	70	8,50	244,86		x
MAREA WEEK END	ESTATE	13120	185B, 185C	01/96					C	1400	70	8,50	244,86		x
MASSIF, CAMPAGNOLA	4WD	13153/C	SANTANA PA	08					C	3000	125	15,50	266,06		x
MASSIF, CAMPAGNOLA	4WD	13153/SF	SANTANA PA	08					SF(C)	3000	125	15,50	294,68		x
MASSIF, CAMPAGNOLA	4WD	13153/G	SANTANA PA	08					GRIFO(C)	3000	125	15,50	434,60		x
MULTIPLA	MPV, methane	13127/F	186A,186B	99					F	1300	70	8,30	233,20		x
MULTIPLA	MPV, methane	13127	186A,186B	99					C	1300	70	8,30	260,76		x
PALIO	HATCHBACK 3-5 doors	13132	178A, 178B	00		x	i		C	1000	70	6,40	290,44		x
PALIO WEEK END	ESTATE	13128/F	178D, 178H	01/98		x	v		F	1200	70	7,90	209,88		x
PALIO WEEK END	ESTATE	13128	178D, 178H	01/98		x	v		C	1200	70	7,90	226,84		x
PANDA	HATCHBACK, 4X4, LPG system under the panel	13154/F	141	82	03	x			F	900	63	5,40	128,26	x	
PANDA	HATCHBACK, 4X4, LPG system under the panel	13154/C	141	82	03	x			C	900	63	5,40	163,24	x	
PANDA	HATCHBACK 4x2, no Natural Power	13168/F	169	10/03	12/11	x	i		F	1137	60	6,30	146,28		x
PANDA	HATCHBACK 4x2, no Natural Power	13168/C	169	10/03	12/11	x	i		C	1137	60	6,30	186,56		x













													
PANDA	HATCHBACK 4x2, no Natural Power	13168/VM	169	10/03	12/11	x	i	VM	1137	60	6,30	338,14	x
PANDA	HATCHBACK 4x4, 4x4 Climbing, 4x4 Cross, no Natural Power	13168/F	169	10/03	12/11	x	i	F	1137	60	6,30	146,28	x
PANDA	HATCHBACK 4x4, 4x4 Climbing, 4x4 Cross, no Natural Power	13168/C	169	10/03	12/11	x	i	C	1137	60	6,30	186,56	x
PANDA	HATCHBACK 4x4, 4x4 Climbing, 4x4 Cross, no Natural Power	13168/VM	169	10/03	12/11	x	i	VM	1137	60	6,30	338,14	x
PANDA	HATCHBACK 5 doors, City Cross Waze, no Natural Power, check towing capacity, no Hybrid	13162/F	312	01/12		x	i	F	900	60	6,70	139,92	x
PANDA	HATCHBACK 5 doors, City Cross Waze, no Natural Power, check towing capacity, no Hybrid	13162/C	312	01/12		x	i	C	900	60	6,70	217,30	x
PANDA	HATCHBACK 5 doors, City Cross Waze, no Natural Power, check towing capacity, no Hybrid	13162/VM	312	01/12		x	i	VM	900	60	6,70	338,14	x
PANDA	4x4, no Natural Power, No City Cross Waze, no Hybrid, check towing capacity	21050/F	312	01/12		x	i	F	900	60	6,70	139,92	x
PANDA	4x4, no Natural Power, No City Cross Waze, no Hybrid, check towing capacity	21050/C	312	01/12		x	i	C	900	60	6,70	232,14	x
PANDA	4x4, no Natural Power, No City Cross Waze, no Hybrid, check towing capacity	21050/VM	312	01/12		x	i	VM	900	60	6,70	321,18	x
PANDA	TREKKING 4x2, no Natural Power, No City Cross Waze, no Hybrid, check towing capacity	21050/F	312	01/12		x	i	F	900	60	6,70	139,92	x
PANDA	TREKKING 4x2, no Natural Power, No City Cross Waze, no Hybrid, check towing capacity	21050/C	312	01/12		x	i	C	900	60	6,70	232,14	x
PANDA	TREKKING 4x2, no Natural Power, No City Cross Waze, no Hybrid, check towing capacity	21050/VM	312	01/12		x	i	VM	900	60	6,70	321,18	x
PANDA CROSS	Cross, City Cross, No City Cross Waze, no Hybrid, check towing capacity	21050/F	312	01/12		x	i	F	900	60	6,70	139,92	x
PANDA CROSS	Cross, City Cross, No City Cross Waze, no Hybrid, check towing capacity	21050/C	312	01/12		x	i	C	900	60	6,70	232,14	x
PANDA CROSS	Cross, City Cross, No City Cross Waze, no Hybrid, check towing capacity	21050/VM	312	01/12		x	i	VM	900	60	6,70	321,18	x
PUNTO	HATCHBACK 3-5 doors	13123	176	01/93	01/99	x	i	C	1100	70	6,50	227,90	x
PUNTO	HATCHBACK 3-5 doors, no Sporting, no Natural Power	13166/F	188	01/99	09/05	x		F	1281	60	7,30	181,26	x
PUNTO	HATCHBACK 3-5 doors, no Sporting, no Natural Power	13166/C	188	01/99	09/05	x		C	1281	60	7,30	224,72	x
PUNTO	HATCHBACK 3-5 doors, no Sporting, no Natural Power	13166/VM	188	01/99	09/05	x		VM	1281	60	7,30	321,18	x
PUNTO	CABRIO	13123	176	94	99	x	i	C	1100	70	6,50	227,90	x
PUNTO EVO	HATCHBACK 3-5 doors, LPG, no Natural Power	13149/F	199	05		x	i	F	1000	75	7,50	171,72	x
PUNTO EVO	HATCHBACK 3-5 doors, , LPG, no Natural Power	13149/C	199	05		x	i	C	1000	75	7,50	239,56	x
PUNTO EVO	HATCHBACK 3-5 doors no Natural Power, LPG	13149/VM	199	05		x	i	VM	1000	75	7,50	338,14	x
QUBO	MPV, Trekking, no Natural Power	13152/F	225	11/08				F	1000	60	6,50	181,26	x
QUBO	MPV, Trekking, no Natural Power	13152	225	11/08				C	1000	60	6,50	235,32	x
SCUDO	VAN	13133/F	220	94	07			F	1300	60	10,50	209,88	x















														
SCUDO	VAN	13133	220	94	07				C	1300	60	10,50	268,18	x
SCUDO	VAN, MINIBUS	13151/F	270	01/07	03/16	x	i		F	2000	80	12,50	174,90	x
SCUDO	VAN, MINIBUS	13151/C	270	01/07	03/16	x	i		C	2000	80	12,50	324,36	x
SCUDO	VAN	07049/F	V	01/22		x			F	2644	120	14,00	181,26	x
SCUDO	VAN	07049/C	V	01/22		x			C	2644	120	14,00	254,40	x
SEDICI	MPV 5 doors 2-4WD. Visible bumper cut on Restyling version	13145/F	FY	01/06	01/15	x	i		F	1200	75	7,80	208,82	x
SEDICI	MPV 5 doors 2-4WD. Visible bumper cut on Restyling version	13145/C	FY	01/06	01/15	x	i		C	1200	75	7,80	278,78	x
SEDICI	MPV 5 doors 2-4WD. Visible bumper cut on Restyling version	13145/VM	FY	01/06	01/15	x	i	VM		1200	75	7,80	354,04	x
SEICENTO	HATCHBACK	13126	187	01/98	04/05				C	400	28	4,00	216,24	x
STILO	HATCHBACK 3-5 doors	13136	192A, 192B	01/01	07/07	x	i		C	1300	60	7,80	301,04	x
STILO MULTI WAGON	ESTATE	13138/C	192	03/03	02/08	x	v		C	1300	60	8,20	330,72	x
STRADA	Pick-up Restyling	13130	178E, 278	99					C	1000	70	7,00	204,58	x
TALENTO	VAN	31103/SF	FFL, FJL	07/16					SF	2366	120	12,50	190,80	x
TALENTO	VAN	31103/G	FFL, FJL	07/16				GRIFO		2366	120	12,50	471,70	x
TEMPRA	Saloon	13101	159	01/90	93	x	v		C	1300	91		179,14	x
TIPO	HATCHBACK 3-5 doors	13100	160	01/88	01/95	x			C	1300	84		171,72	x
TIPO	Saloon 4 doors, HATCHBACK 5 doors, ESTATE, Cross	13167/F	356	10/15		x	v		F	1500	60	9,00	202,46	x
TIPO	Saloon 4 doors, HATCHBACK 5 doors, ESTATE, Cross	13167/C	356	10/15		x	v		C	1500	60	9,00	293,62	x
TIPO	Saloon 4 doors, HATCHBACK 5 doors, ESTATE, Cross	13167/VM	356	10/15		x	v	VM		1500	60	9,00	362,52	x
ULYSSE	MPV, bumper cut according to the version	13133/F	220	94	2				F	1300	60	10,50	209,88	x
ULYSSE	MPV, bumper cut according to the version	13133	220	94	02				C	1300	60	10,50	268,18	x
ULYSSE	MPV	13137/F	179	03/02			i		F	1850	76	11,00	209,88	x
ULYSSE	MPV	13137/C	179	03/02			i		C	1850	76	11,00	295,74	x
UNO	HATCHBACK 3-5 doors, no CS	13098	146	82	89	x			C	1000	63		185,50	x
UNO	CS HATCHBACK	13078	146	89		x	v		C	1000	63		208,82	x
UNO	HATCHBACK 3-5 doors Restyling	13106	146	01/89	01/94	x			C	900	70		173,84	x
FORD														
B-MAX	MPV	14089/F	JK8	07/12		x			F	900	50	7,05	184,44	x
B-MAX	MPV	14089/C	JK8	07/12		x			C	900	50	7,05	294,68	x
B-MAX	MPV	14089/VM	JK8	07/12		x		VM		900	50	7,05	383,72	x
C-MAX	MPV	14078/F	DM2, DXA	07/10		x			F	1500	75	9,30	160,06	x
C-MAX	MPV	14078/C	DM2, DXA	07/10		x			C	1500	75	9,30	312,70	x
C-MAX	MPV	14078/VM	DM2, DXA	07/10		x		VM		1500	75	9,30	339,20	x
ECOSPORT	2-4WD with spare wheel on the rear door	14093/C	JK8	05/14	09/17	x	i		C	822	50	5,50	307,40	x
ECOSPORT	2-4WD without spare wheel on the rear door	14097/F	JK8	05/14	09/17	x	i		F	822	50	5,50	215,18	x
ECOSPORT	2-4WD without spare wheel on the rear door	14097/C	JK8	05/14	09/17	x	i		C	822	50	5,50	307,40	x
ECOSPORT	2WD, AWD, without spare wheel on the rear door	14102/F	JK8	10/17					F	1279	75	7,50	215,18	

















														
ECOSPORT	2WD, AWD, without spare wheel on the rear door	14102/C	JK8	10/17				C	1279	75	7,50	307,40		
ECOSPORT	2WD, AWD, without spare wheel on the rear door	14102/VM	JK8	10/17				VM	1279	75	7,50	365,70		
EDGE	2-4WD, Sport	14099/F	SBF	01/16	12/18	x		F	2351	120	12,00	204,58		x
EDGE	2-4WD, Sport	14099/C	SBF	01/16	12/18	x		C	2351	120	12,00	312,70		x
EDGE	2-4WD, Sport	14099/VM	SBF	01/16	12/18	x		VM	2351	120	12,00	355,10		x
ESCORT	1.8 16V – ESTATE	14051/1	ANL	90	99	x		C	1000	50		242,74	x	
ESCORT	1.8 16V HATCHBACK 3-5 doors, CABRIO	14052/1	AAL, ABL, ALL	90	92	x	v	C	1000	50		248,04	x	
ESCORT	HATCHBACK 3-5 doors, CABRIO	14052	AAL, ABL, ALL	90	92	x	v	C	1000	50		236,38	x	
ESCORT	HATCHBACK 3-5 doors, CABRIO	14058	AAL, ABL, ALL	08/92	01/98	x	v	C	1150	50		236,38	x	
FIESTA	HATCHBACK 3-5 doors, check if it is possible to tow	14064	JAS, JBS, JVS	01/96	12/01		v	C	900	50	6,00	244,86	x	
FIESTA	HATCHBACK 3-5 doors, VAN, PRO	14057	FAJ, FBI, FVJ	89	95	x	v	C	900	50		240,62	x	
FIESTA		14101/F	JA8, JR8	10/08	12/16	x	i	F	1306	75	7,00	207,76		x
FIESTA		14101/C	JA8, JR8	10/08	12/16	x	i	C	1306	75	7,00	286,20		x
FIESTA		14101/VM	JA8, JR8	10/08	12/16	x	i	VM	1306	75	7,00	358,28		x
FIESTA		14101/F	JHH	01/17		x	i	F	1306	75	7,00	207,76		x
FIESTA		14101/C	JHH	01/17		x	i	C	1306	75	7,00	286,20		x
FIESTA		14101/VM	JHH	01/17		x	i	VM	1306	75	7,00	358,28		x
FIESTA	HATCHBACK 3-5 doors Restyling, no S - ST	14076	JH1, JD3, JC3	01/02	09/08	x	v	C	900	50	6,30	287,26		x
FIESTA	S, ST SPORT VERSION	14076/S	JH1, JD3, JC3	05	08	x	v	C	900	50	6,30	287,26		x
FOCUS	HATCHBACK 3-5 doors	14069	DAW, DBW	01/98	09/04	x	v	C	1300	50	7,60	297,86	x	
FOCUS	HATCHBACK 3-5 doors, Restyling '08, ST-LINE	14078/F	DA3, DYB	05/05	08/18	x		F	1500	75	9,30	160,06		x
FOCUS	HATCHBACK 3-5 doors, Restyling '08, ST-LINE	14078/C	DA3, DYB	05/05	08/18	x		C	1500	75	9,30	312,70		x
FOCUS	HATCHBACK 3-5 doors, Restyling '08, ST-LINE	14078/VM	DA3, DYB	05/05	08/18	x		VM	1500	75	9,30	339,20		x
FOCUS C-MAX	MPV, Restyling '07	14078/F	DM2	09/03	06/10	x	v	F	1500	75	9,30	160,06		x
FOCUS C-MAX	MPV, Restyling '07	14078/C	DM2	09/03	06/10	x	v	C	1500	75	9,30	312,70		x
FOCUS C-MAX	MPV, Restyling '07	14078/VM	DM2	09/03	06/10	x	v	VM	1500	75	9,30	339,20		x
FOCUS STYLE WAGON	ESTATE	14070	DNW	01/98	09/04			C	1300	50	7,80	274,54	x	
FOCUS STYLE WAGON	ESTATE, Restyling '08	14080/F	DA3, DM2	10/04	04/11			F	1500	75	8,90	160,06		x
FOCUS STYLE WAGON	ESTATE, Restyling '08	14080/C	DA3, DM2	10/04	04/11			C	1500	75	8,90	301,04		x
FOCUS WAGON	ESTATE	14087/F	DYB	05/11	09/18	x	v	F	1500	75	9,80	171,72		x
FOCUS WAGON	ESTATE	14087/C	DYB	05/11	09/18	x	v	C	1500	75	9,80	259,70		x
FOCUS WAGON	ESTATE	14087/VM	DYB	05/11	09/18	x	v	VM	1500	75	9,80	349,80		x
FOCUS SW	ESTATE, Vignale	14104/F	DEH	10/18		x	i	F	2267	90	10,30	169,60		x
FOCUS SW	ESTATE, Vignale	14104/C	DEH	10/18		x	i	C	2267	90	10,30	275,60		x
FOCUS SW	ESTATE, Vignale	14104/VM	DEH	10/18		x	i	VM	2267	90	10,30	379,48		x
FUSION	MPV, no parking sensors, no Titanium	14077/F	JU2	12/02		x		F	900	50	6,30	209,88		x
FOCUS 2 VOLUMI 3-5 porte	HATCHBACK 3-5 doors	14103/F	DEH	09/18		x	i	F	2254	90	10,10	233,20		x
FOCUS 2 VOLUMI 3-5 porte	HATCHBACK 3-5 doors	14103/C	DEH	09/18		x	i	C	2254	90	10,10	338,14		x
FOCUS 2 VOLUMI 3-5 porte	HATCHBACK 3-5 doors	14103/VM	DEH	09/18		x	i	VM	2254	90	10,10	386,90		x















														
FUSION	MPV, no parking sensors, no Titanium	14077	JU2	12/02		x		C	900	50	6,30	287,26	x	
GALAXY	MPV 1st series, 4X4	14063/1	WGR	96	01/99	x	v	C	2085	85	11,66	262,88	x	
GALAXY	MPV 1st SERIES, 4x4	14063/1F	WGR	96	01/99	x	v	F	2085	85	11,66	221,54	x	
GALAXY	MPV Restyling, 4X4	14063/2	WGR	00	05/06	x		C	2085	85	11,66	262,88	x	
GALAXY	MPV Restyling, 4x4	14063/2F	WGR	00	05/06	x		F	2085	85	11,66	221,54	x	
GALAXY	MPV 2nd SERIES	14082G/F	WA6?????M	06/06	08/15	x	i	F	1750	80	11,20	171,72	x	
GALAXY	MPV 2nd SERIES	14082G/C	WA6?????M	06/06	08/15	x	i	C	1750	80	11,20	274,54	x	
GALAXY	MPV 2nd SERIES	14082G/VM	WA6?????M	06/06	08/15	x	i	VM	1750	80	11,20	355,10	x	
GALAXY	MPV	14098/F	WA6	09/15		x	i	F	2338	90	12,00	181,26	x	
GALAXY	MPV	14098/C	WA6	09/15		x	i	C	2338	90	12,00	286,20	x	
GALAXY	MPV	14098/VM	WA6	09/15		x	i	VM	2338	90	12,00	355,10	x	
GRAND C-MAX	MPV	14078/F	DM2, DXA	07/10		x		F	1500	75	9,30	160,06	x	
GRAND C-MAX	MPV	14078/C	DM2, DXA	07/10		x		C	1500	75	9,30	312,70	x	
GRAND C-MAX	MPV	14078/VM	DM2, DXA	07/10		x		VM	1500	75	9,30	339,20	x	
KUGA	SUV, Restyling '17	14085/F	DM2	03/08	06/19	x		F	2100	105	11,20	220,48	x	
KUGA	SUV, Restyling '17	14085/C	DM2	03/08	06/19	x		C	2100	105	11,20	309,52	x	
KUGA	SUV, Restyling '17	14085/VM	DM2	03/08	06/19	x		VM	2100	105	11,20	334,96	x	
KUGA III	SUV 2-4WD, AdBlue, ST-LINE	14105/F	DFK	07/20	19	x	i	F	1900	120	11,00	254,40	x	
KUGA III	SUV 2-4WD, AdBlue, ST-LINE	14105/C	DFK	07/20	19	x	i	C	1900	120	11,00	284,08	x	
KUGA III	SUV 2-4WD, AdBlue, ST-LINE	14105/VM	DFK	07/20	19	x	i	VM	1900	120	11,00	397,50	x	
KUGA III	HYBRID	14109/F	DFK	07/20	19	x	i	F	1900	120	11,00	220,00	x	
KUGA III	HYBRID	14109/C	DFK	07/20	19	x	i	C	1900	120	11,00	295,00	x	
KUGA III	HYBRID	14109/VM	DFK	07/20	19	x	i	VM	1900	120	11,00	360,00	x	
MAVERICK	4WD 2-4 doors	26010	R20	01/93	01			C	3000	120	13,67	242,74	x	
MONDEO	HATCHBACK 5 doors	14084/F	BA7?????E	06/07	11/14	x		F	2000	80	11,30	184,44	x	
MONDEO	HATCHBACK 5 doors	14084/C	BA7?????E	06/07	11/14	x		C	2000	80	11,30	291,50	x	
MONDEO	HATCHBACK 5 doors	14084/VM	BA7?????E	06/07	11/14	x		VM	2000	80	11,30	339,20	x	
MONDEO	HATCHBACK 4-5 doors	14095/F	BA7	12/14		x	i	F	2575	90	12,00	184,44	x	
MONDEO	HATCHBACK 4-5 doors	14095/C	BA7	12/14		x	i	C	2575	90	12,00	291,50	x	
MONDEO	HATCHBACK 4-5 doors	14095/VM	BA7	12/14		x	i	VM	2575	90	12,00	339,20	x	
MONDEO	HATCHBACK 4-5 doors, HYBRID	14107/F	BA7	12/14		x	i	F	2575	90	12,00	212,00	x	
MONDEO	HATCHBACK 4-5 doors, HYBRID	14107/C	BA7	12/14		x	i	C	2575	90	12,00	275,60	x	
MONDEO	HATCHBACK 4-5 doors, HYBRID	14107/VM	BA7	12/14		x	i	VM	2575	90	12,00	365,70	x	
MONDEO	Saloon, HATCHBACK, 4x4	14059	BAP, BFP	01/93	97	x	v	C	1300	60		251,22	x	
MONDEO	Saloon, HATCHBACK	14073/C	B4Y, B5Y	01/01	08/07		v	C	1800	75	10,20	296,80	x	
MONDEO	Saloon, HATCHBACK	14073/F	B4Y, B5Y	01/01	08/07		v	F	1800	75	10,20	198,22	x	
MONDEO	Saloon 4 doors, Titanium	14083B/F	BA7?????D	06/07	11/14	x		F	2000	80	11,30	184,44	x	
MONDEO	Saloon 4 doors, Titanium	14083B/C	BA7?????D	06/07	11/14	x		C	2000	80	11,30	291,50	x	
MONDEO	Saloon 4 doors, Titanium	14083B/VM	BA7?????D	06/07	11/14	x		VM	2000	80	11,30	339,20	x	
MONDEO WAGON	ESTATE, 4X4	14067	BNP	01/93	01/00		v	C	1500	75	9,20	251,22	x	
MONDEO WAGON	ESTATE with Self - Leveling	14074/C2	BWY	01/01	08/07	x	i	C	1800	75	10,00	296,80	x	
MONDEO WAGON	ESTATE with Self - Leveling	14074/F2	BWY	01/01	08/07	x	i	F	1800	75	10,00	198,22	x	
MONDEO WAGON	ESTATE with no Self - Leveling	14074/C1	BWY	01/01	08/07	x	i	C	1800	75	10,00	296,80	x	















													
MONDEO WAGON	ESTATE, with no Self - Leveling	14074/F1	BWY	01/01	08/07	x	i	F	1800	75	10,00	198,22	x
MONDEO WAGON	ESTATE	14083W/F	BA7?????G	06/07	11/14	x	i	F	2000	80	11,30	184,44	x
MONDEO WAGON	ESTATE	14083W/C	BA7?????G	06/07	11/14	x	i	C	2000	80	11,30	291,50	x
MONDEO WAGON	ESTATE	14083W/VM	BA7?????G	06/07	11/14	x	i	VM	2000	80	11,30	339,20	x
MONDEO WAGON	ESTATE	14095/F	BA7	12/14		x	i	F	2575	90	12,00	184,44	x
MONDEO WAGON	ESTATE	14095/C	BA7	12/14		x	i	C	2575	90	12,00	291,50	x
MONDEO WAGON	ESTATE	14095/VM	BA7	12/14		x	i	VM	2575	90	12,00	339,20	x
ORION - ESCORT	Saloon 1.8 16V 4 doors	14053/1	AFL	90	94	x		C	900	50		260,76	x
ORION - ESCORT	Saloon 4 doors	14053	AFL	90	94	x	v	C	1000	50		251,22	x
PUMA	ST-LINE	14106/F	J2K	09/20 19		x	i	F	1305	85	7,50	180,20	x
PUMA	ST-LINE	14106/C	J2K	09/20 19		x	i	C	1305	85	7,50	275,60	x
PUMA	ST-LINE	14106/VM	J2K	09/20 19		x	i	VM	1305	85	7,50	376,30	x
RANGER	PICK-UP 4WD, for the Wildtrack order also the spacer for the towball	14081/G	2AW	99	12/11	x		GRIFO	3000	112	15,00	456,86	x
RANGER	PICK-UP 4WD, for the Wildtrack order also the spacer for the towball	14081/SF	2AW	99	12/11	x		SF	3000	112	15,00	275,60	x
RANGER	PICK-UP 4WD, 2WD ONLY INCREASED RIDE HEIGHT, AdBlue, Wildtrack	14096/SF	2AB	01/12		x		SF	3500	200	16,60	239,56	x
RANGER	PICK-UP 4WD, 2WD ONLY INCREASED RIDE HEIGHT, AdBlue, Wildtrack	14096/G	2AB	01/12		x		GRIFO	3500	200	16,60	455,80	x
RANGER	PICK-UP 4WD, 2WD ONLY INCREASED RIDE HEIGHT, AdBlue, Wildtrack	14096/SFM	2AB	01/12		x		SFM	3500	200	16,60	455,80	x
S-MAX	MPV	14082S/F	WA6?????S	03/06	08/15	x	i	F	1800	80	11,20	171,72	x
S-MAX	MPV	14082S/C	WA6?????S	03/06	08/15	x	i	C	1800	80	11,20	322,24	x
S-MAX	MPV	14082S/VM	WA6?????S	03/06	08/15	x	i	VM	1800	80	11,20	386,90	x
S-MAX	ESTATE, no spare wheel under the panel	14098/F	WA6	09/15		x	i	F	2338	90	12,00	181,26	x
S-MAX	ESTATE, no spare wheel under the panel	14098/C	WA6	09/15		x	i	C	2338	90	12,00	286,20	x
S-MAX	ESTATE, no spare wheel under the panel	14098/VM	WA6	09/15		x	i	VM	2338	90	12,00	355,10	x
TRANSIT	PICK UP, also for chassis vehicles	14072	FM?Y, FN?Y, FC?Y, FN?6, FM?6	04/00				SF	2790	112	16,70	184,44	x
TRANSIT	VAN	14071	FD?Y, FA?Y, FC?Y, FD?6, AGF, ADF, FB?Y, FZ?6	01/00	14	x		C	2800	112	16,00	246,98	x
TRANSIT	VAN	14092/SF	FCD, FAD, FED	14				SF	3500	140	17,17	184,44	x
TRANSIT	VAN	14092/G	FCD, FAD, FED	14				GRIFO	3500	140	17,17	378,42	x
TRANSIT	VAN, HYBRID	14108/SF	FCD, FAD, FED, PVD	05/19				SF	3500	140	17,17	206,70	x
TRANSIT	VAN, HYBRID	14108/G	FCD, FAD, FED, PVD	05/19				GRIFO	3500	140	17,17	445,20	x
TRANSIT CONNECT	VAN, check towing capacity	14091/F	P?2	13	08/22	x		F	1700	75	9,90	184,44	x
TRANSIT CONNECT	VAN, check towing capacity	14091/C	P?2	13	08/22	x		C	1700	75	9,90	277,72	x
TRANSIT CONNECT	VAN, check towing capacity	14091/VM	P?2	13	08/22	x		VM	1700	75	9,90	390,08	x
TRANSIT CONNECT S, L	VAN, check D value, no petrol version	14079	P?2	01/02	12			C	1200	50	8,00	236,38	x















													
TRANSIT COURIER	VAN, No AdBlue	14094/SF	JN8	02/14				SF	1271	50	7,30	196,10	x
TRANSIT COURIER	VAN, No AdBlue	14094/G	JN8	02/14				GRIFO	1271	50	7,30	456,86	x
TOURNEO COURIER	VAN, No AdBlue	14094/SF	JU2	02/14				SF	1271	50	7,30	196,10	x
TOURNEO COURIER	VAN, No AdBlue	14094/G	JU2	02/14				GRIFO	1271	50	7,30	456,86	x
TRANSIT CUSTOM	VAN	14090/SF	F?C, F?A	10/12				SF	2800	112	15,85	196,10	x
TOURNEO CUSTOM	VAN	14090/SF	F?C, F?A	10/12				SF	2800	112	15,85	196,10	x
TRANSIT CUSTOM	VAN	14090/G	F?C, F?A	10/12				GRIFO	2800	112	15,85	456,86	x
TOURNEO CUSTOM	VAN	14090/G	F?C, F?A	10/12				GRIFO	2800	112	15,85	456,86	x
TRANSIT TOURNEO	VAN, check D value, no petrol version	14079	P?2	01/02	12			C	1200	50	8,00	236,38	x
TRANSIT TOURNEO	VAN, check towing capacity	14091/F	P?2	13	07/22	x		F	1700	75	9,90	184,44	x
TRANSIT TOURNEO	VAN, check towing capacity	14091/C	P?2	13	07/22	x		C	1700	75	9,90	277,72	x
TRANSIT TOURNEO	VAN, check towing capacity	14091/VM	P?2	13	07/22	x		VM	1700	75	9,90	390,08	x
GREAT WALL													
HOVER	LPG, no KIT SPORT VERSION	14201/SF	CC	06		x	i	SF	2500	100	12,50	294,68	x
HOVER	LPG, no KIT SPORT VERSION	14201/C	CC	06		x	i	C	2500	100	12,50	253,34	x
HOVER	LPG, no KIT SPORT VERSION	14201/G	CC	06		x	i	GRIFO	2500	100	12,50	430,36	x
STEED	PICK UP, LPG, Work , No Premium	14202/F	K2, NBP, K2/G	09		x		F	2000	100	12,50	209,88	x
STEED	PICK UP, LPG, Work , No Premium	14202/C	K2, NBP, K2/G	09		x		C	2000	100	12,50	255,46	x
STEED	PICK UP, LPG, Work , No Premium	14202/SF	K2, NBP, K2/G	09		x		SF(C)	2000	100	12,50	296,80	x
STEED	PICK UP, LPG, Work , No Premium	14202/G	K2, NBP, K2/G	09		x		GRIFO(C)	2000	100	12,50	432,48	x
STEED	PICK UP, LPG, Premium	14203/F	K2, NBP, K2/G	19		x		F	2000	100	12,50	209,88	x
STEED	PICK UP, LPG, Premium	14203/C	K2, NBP, K2/G	19		x		C	2000	100	12,50	255,46	x
STEED	PICK UP, LPG, Premium	14203/SF	K2, NBP, K2/G	19		x		SF(C)	2000	100	12,50	296,80	x
STEED	PICK UP, LPG, Premium	14203/G	K2, NBP, K2/G	19		x		GRIFO(C)	2000	100	12,50	432,48	x
HONDA													
CIVIC	HATCHBACK 3 doors	15011/3	EP	01/02	10/06	x	i	C	1200	50	7,40	259,70	x
CIVIC	HATCHBACK 5 doors	15011/5	EU	01/01	10/06	x	i	C	1200	50	7,40	259,70	x
CR-V	4WD 4 doors	15010	RD1, RD3	98	12/01			C	1500	70	9,20	321,18	x
CR-V	4WD 4 doors	15013	RD8, RD9	01/02	12/06			C	1500	60	9,80	321,18	x
CR-V	4WD 4 doors	15014	RE6, RE5	01/07	09/12	x	i	C	2000	100	10,60	321,18	x
CR-V	4WD 4 doors, 2WD	15016/F	RE5, RE6	10/12	09/18		i	F	2000	100	11,00	192,92	x
CR-V	4WD 4 doors, 2WD	15016/C	RE5, RE6	10/12	09/18		i	C	2000	100	11,00	307,40	x
CR-V	4WD 4 doors, 2WD	15016/VM	RE5, RE6	10/12	09/18		i	VM	2000	100	11,00	383,72	x
HR-V	2-4WD 2-4 doors	15009	GH	01/99	02	x	v	C	1200	60	8,00	274,54	x
HR-V	4WD 2-4 doors Restyling	15012	GH	02	10/06	x	v	C	1200	60	8,00	276,66	x
JAZZ	HATCHBACK 5 doors	15015/C	GG1, GG2, GG3	08	2016	x	i	C	1000	95	6,50	321,18	x
HYUNDAI													
ACCENT/VERNA	Saloon 3-4-5 doors, HATCHBACK	45008	LC	01/99	05/06		v	C	1100	50	7,00	288,32	x
ATOS	VAN	45005	ATOS, MX	98				C	800	28	5,20	260,76	x
ATOS PRIME	HATCHBACK	45005	ATOS, MX	98	08/03			C	800	28	5,20	260,76	x
ATOS/MULTI	MPV 5 doors	45005	ATOS, MX	01/98				C	800	28	5,20	260,76	x
GALLOPER	4WD 2 doors SHORT	45003	JK-T01..L1	01/98				C	3300	120	14,50	279,84	x
GALLOPER	4WD 4 doors LONG	45004	JK-T01..L2	01/98				C	3300	120	14,50	296,80	x
GETZ	HATCHBACK rear fog light on the left	45012	TB	01/02	05	x	i	C	1100	44	7,00	340,26	x















														
GETZ	HATCHBACK Restyling	45014/F	TB, TBI	05		x	i	F	1100	44	7,00	233,20	x	
GETZ	HATCHBACK Restyling	45014/C	TB, TBI	05		x	i	C	1100	44	7,00	307,40	x	
GRAND SANTA FE	2-4WD	19117/F	DM	04/16	06/18	x	v	F	2621	100	13,00	192,92		x
GRAND SANTA FE	2-4WD	19117/C	DM	04/16	06/18	x	v	C	2621	100	13,00	294,68		x
GRAND SANTA FE	2-4WD, the towball holder remains slightly visible	19117/VM	DM	04/16	06/18	x	v	VM	2621	100	13,00	355,10		x
H1/H300	VAN or BUS	45019	TQ	01/08			i	C	2300	100	14,00	337,08		x
i10	Towbar not suitable for towing, but can only be used to install a bicycle rack and other car rack devices	45023		11/13	08/19				0	50		263,94		x
i10	MPV 5 doors, Restyling '10, ACTIVE (bumper cut)	45016/F	PA	01/08	11/13			F	700	28	5,30	184,44		x
i10	MPV 5 doors, Restyling '10, ACTIVE (bumper cut)	45016	PA	01/08	11/13			C	700	28	5,30	263,94		x
i20	HATCHBACK 3-5 doors, Dual Fuel	45020/F	PB F, PB G, PB T	09	12/14	x	i	F	1100	50	6,90	171,72		x
i20	HATCHBACK 3-5 doors, Dual Fuel	45020/C	PB F, PB G, PB T	09	12/14	x	i	C	1100	50	6,90	265,00		x
i20	HATCHBACK 3-5 doors, Dual Fuel	45020/VM	PB F, PB G, PB T	09	12/14	x	i	VM	1100	50	6,90	323,30		x
i20	HATCHBACK 3-5 doors, Active	45025/F	GB	01/15	12/19	x	v	F	1210	75	6,90	163,24		x
i20	HATCHBACK 3-5 doors, Active	45025/C	GB	01/15	12/19	x	v	C	1210	75	6,90	265,00		x
i20	HATCHBACK 3-5 doors, Active	45025/VM	GB	01/15	12/19	x	v	VM	1210	75	6,90	344,50		x
i30	HATCHBACK 5 doors	45017/F	FDB, FDH	08	12		i	F	1500	75	8,70	184,44		x
i30	HATCHBACK 5 doors	45017/C	FDB, FDH	08	12		i	C	1500	75	8,70	288,32		x
i30	HATCHBACK 5 doors	45017/VM	FDB, FDH	08	12		i	VM	1500	75	8,70	365,70		x
i30 CW	ESTATE, Dual Fuel	45018/1F	PDF, FDH	08	06/12		i	F	1500	75	9,00	184,44		x
i30 CW	ESTATE, Dual Fuel	45018/1C	PDF, FDH	08	06/12		i	C	1500	75	9,00	298,92		x
i30 CW	ESTATE, Dual Fuel	45018/1VM	PDF, FDH	08	06/12		i	VM	1500	75	9,00	365,70		x
i30 CW	ESTATE	19114/F	JD, GD	07/12	06/17	x	i	F	1500	75	8,80	184,44		x
i30 CW	ESTATE	19114/C	JD, GD	07/12	06/17	x	i	C	1500	75	8,80	307,40		x
i30 CW	ESTATE	19114/VM	JD, GD	07/12	06/17	x	i	VM	1500	75	8,80	365,70		x
i40 CW	ESTATE, No AdBlue	45022/F	VFC	07/11		x	i	F	1800	80	10,00	178,08		x
i40 CW	ESTATE, No AdBlue	45022/C	VFC	07/11		x	i	C	1800	80	10,00	275,60		x
i40 CW	ESTATE, No AdBlue	45022/VM	VFC	07/11		x	i	VM	1800	80	10,00	355,10		x
iX20	MPV	19113/F	JC	10/10		x	i	F	1300	80	7,60	171,72		x
iX20	MPV	19113/C	JC	10/10		x	i	C	1300	80	7,60	275,60		x
iX20	MPV	19113/VM	JC	10/10		x	i	VM	1300	80	7,60	355,10		x
iX35	SUV 2-4WD	19111/HF	EL	03/10		x	v	F	2000	80	10,80	171,72		x
iX35	SUV 2-4WD	19111/HC	EL	03/10		x	v	C	2000	80	10,80	270,30		x
iX35	SUV 2-4WD	19111/HVM	EL	03/10		x	v	VM	2000	80	10,80	356,16		x
KONA	2-4WD, AdBlue	45028/F	OS	10/17		x	i	F	1474	80	7,90	198,22		x
KONA	2-4WD, AdBlue	45028/C	OS	10/17		x	i	C	1474	80	7,90	314,82		x
KONA	2-4WD, AdBlue	45028/VM	OS	10/17		x	i	VM	1474	80	7,90	371,00		x
KONA	HYBRID, check towing capacity	45032/F	OS	10/17		x	i	F	1474	80	7,90	190,80		x
KONA	HYBRID, check towing capacity	45032/C	OS	10/17		x	i	C	1474	80	7,90	280,90		x
KONA	HYBRID, check towing capacity	45032/VM	OS	10/17		x	i	VM	1474	80	7,90	371,00		x
LANTRA	Saloon	45006	RD, JF, JW	96	08/00		i	C	1400	75	8,30	303,16	x	
LANTRA COUPE'	COUPE'	45006	RD, JF, JW	96	00		i	C	1400	75	8,30	303,16	x	















															
LANTRA WAGON	ESTATE	45006	RD, JF, JW	96	08/00			C	1400	75	8,30	303,16	x		
MATRIX	MPV	45010	FC	01	09/08	x	v	C	1300	52	8,00	326,48	x		
SANTA FE	SUV 4WD, Restyling	45009	SM	01/01	02/06	x	v	C	2300	92	12,50	326,48	x		
SANTA FE	SUV 4WD	45015/F	CM	03/06	09/12	x	v	F	2500	88	12,50	202,46		x	
SANTA FE	SUV 4WD	45015/C	CM	03/06	09/12	x	v	C	2500	88	12,50	328,60		x	
SANTA FE	SUV 4WD, not for models with SMARTKEY function	19115/F	DM	09/12	03/16		v	F	2500	100	13,00	202,46		x	
SANTA FE	SUV 4WD, not for models with SMARTKEY function	19115/C	DM	09/12	03/16		v	C	2500	100	13,00	307,40		x	
SANTA FE	SUV 4WD, not for models with SMARTKEY function	19115/VM	DM	09/12	03/16		v	VM	2500	100	13,00	355,10		x	
SANTA FE	2-4WD	19117/F	DM	04/16	06/18	x	v	F	2621	100	13,00	192,92		x	
SANTA FE	2-4WD	19117/C	DM	04/16	06/18	x	v	C	2621	100	13,00	294,68		x	
SANTA FE	2-4WD, the towball holder remains slightly visible	19117/VM	DM	04/16	06/18	x	v	VM	2621	100	13,00	355,10		x	
SANTA FE	4WD	19117/F	TM	07/18	01/20	x	v	F	2621	100	13,00	192,92		x	
SANTA FE	4WD	19117/C	TM	07/18	01/20	x	v	C	2621	100	13,00	294,68		x	
SANTA FE	4WD, the towball holder remains slightly visible	19117/VM	TM	07/18	01/20	x	v	VM	2621	100	13,00	355,10		x	
TERRACAN	4WD	45011/F	HP	01/01				F	2800	115	14,50	286,20	x		
TERRACAN	4WD	45011	HP	01/01				C	2800	115	14,50	327,54	x		
TUCSON	SUV 2-4WD	45021/F	JM	09/04	09		v	F	1600	75	10,50	178,08		x	
TUCSON	SUV 2-4WD	45021/C	JM	09/04	09		v	C	1600	75	10,50	283,02		x	
TUCSON	SUV 2-4WD	45021/VM	JM	09/04	09		v	VM	1600	75	10,50	356,16		x	
TUCSON	SUV 2-4WD	45024/F	ELH, TLE	08/15	09/18			F	2440	100	11,50	178,08		x	
TUCSON	SUV 2-4WD	45024/C	ELH, TLE	08/15	09/18			C	2440	100	11,50	270,30		x	
TUCSON	SUV 2-4WD	45024/VM	ELH, TLE	08/15	09/18			VM	2440	100	11,50	356,16		x	
TUCSON	SUV 2-4WD, AdBlue	45027/F	TLE, QLE	09/18	10/20	x	i	F	2440	100	11,50	178,08		x	
TUCSON	SUV 2-4WD, AdBlue	45027/C	TLE, QLE	09/18	10/20	x	i	C	2440	100	11,50	283,02		x	
TUCSON	SUV 2-4WD, AdBlue	45027/VM	TLE, QLE	09/18	10/20	x	i	VM	2440	100	11,50	356,16		x	
TUCSON	SUV 2-4WD, AdBlue	45027/F	TLE, QLE, NX4E	11/20		x	i	F	2440	100	11,50	178,08		x	
TUCSON	SUV 2-4WD, AdBlue	45027/C	TLE, QLE, NX4E	11/20		x	i	C	2440	100	11,50	283,02		x	
TUCSON	SUV 2-4WD, AdBlue	45027/VM	TLE, QLE, NX4E	11/20		x	i	VM	2440	100	11,50	356,16		x	
TUCSON	HYBRID	45029/F	NX4E, TLE	10/18		x	i	F	2440	100	11,50	233,20		x	
TUCSON	HYBRID	45029/C	NX4E, TLE	10/18		x	i	C	2440	100	11,50	312,70		x	
TUCSON	HYBRID	45029/VM	NX4E, TLE	10/18		x	i	VM	2440	100	11,50	402,80		x	
INFINITI															
Q30	AWD	23052G/F	H	01/16		x		F	1815	75	9,60	147,34		x	
Q30	AWD	23052G/C	H	01/16		x		C	1815	75	9,60	258,64		x	
Q30	AWD	23052G/VM	H	01/16		x		VM	1815	75	9,60	365,70		x	
QX30	AWD	23052G/F	H	01/16		x		F	1815	75	9,60	147,34		x	
QX30	AWD	23052G/C	H	01/16		x		C	1815	75	9,60	258,64		x	
QX30	AWD	23052G/VM	H	01/16		x		VM	1815	75	9,60	365,70		x	
INNOCENTI															
ELBA	PANORAMA	13074	146	85	97			C	1000	70		215,18	x		
MILLE	HATCHBACK 3-5 doors	13078	146	94	96			C	900	63		208,82	x		















														
ISUZU														
D-MAX	2-4WD CHASSIS N. MPATFR, MPATFS54, MPATFS77, with chromed bumper request lowering kit from ISUZU	17004	TF	01/04	05/12	x		C	3000	100	15,60	360,40	x	
D-MAX	4WD, no double tubular bumper (COD. 17004)	17005/SF	TFS 8, TFS 77	06	05/12	x		SF(C)	3000	120	15,20	270,30	x	
D-MAX	4WD, no double tubular bumper (COD. 17004)	17005/C	TFS 8, TFS 77	06	05/12	x		C	3000	120	15,20	332,84	x	
D-MAX	4WD, no double tubular bumper (COD. 17004)	17005/G	TFS 8, TFS 77	06	05/12	x		GRIFO(C)	3000	120	15,20	542,72	x	
D-MAX	4WD step bumper, Restyling '16, no double tubular bumper, no 4x2	17007/SF	ATFS 8	06/12	12/19	x		SF(C)	3000	120	15,50	270,30	x	
D-MAX	4WD step bumper, Restyling '16, no double tubular bumper, no 4x2	17007/SFM	ATFS 8	06/12	12/19	x		SFM(C)	3000	120	15,50	545,90	x	
D-MAX	4WD step bumper, Restyling '16, no double tubular bumper, no 4x2	17007/C	ATFS 8	06/12	12/19	x		C	3000	120	15,50	323,30	x	
D-MAX	4WD step bumper, Restyling '16, no double tubular bumper, no 4x2	17007/G	ATFS 8	06/12	12/19	x		GRIFO(C)	3000	120	15,50	545,90	x	
D-MAX	4WD step bumper, no double tubular bumper, with towing capacity of kg 3500, no 4x2	17008	ATFS 86C, ATFS 87C	13	12/19	x		C	3500	245	16,20	323,30	x	
D-MAX	2-4WD	17009/SF	ATF	06/12	12/19			SF	4124	245	17,20	270,30	x	
D-MAX	2-4WD	17009/SFM	ATF	06/12	12/19			SFM	4124	245	17,20	545,90	x	
D-MAX	Regular Cab, Extend Cab, Crew Cab	17010/C	ATFS 87C, BTF S87C	01/20				C	3673	245	16,20	360,40		x
N SERIES	NO NLR85A, NLSA	17006/SFM	NLR, NMR, NNR, NPR, N1R	07				SFM	3500	140	23,70	456,86	x	
N SERIES	NO NLR85A, NLSA	17006/G	NLR, NMR, NNR, NPR, N1R	07				GRIFO	3500	140	23,70	534,24	x	
PICK-UP	4WD chassis NJAA...	17002	TFS	88	03			C	2000	120	11,70	267,12	x	
TROOPER	4WD, check D value	17003	UBS, UBB	01/92	01/97			C	3300	135	15,00	295,74	x	
JAGUAR														
E-PACE	SUV 2-4WD	18002/F	DF	09/17		x	V	F	2104	100	11,00	239,56		x
E-PACE	SUV 2-4WD	18002/C	DF	09/17		x	V	C	2104	100	11,00	332,84		x
F-PACE	SUV 4WD	03030/F	DC	01/16		x	i	F	2691	100	13,00	239,56		
F-PACE	SUV 4WD	03030/C	DC	01/16		x	i	C	2691	100	13,00	332,84		
F-PACE	SUV 4WD	03030/VM	DC	01/16		x	i	VM	2691	100	13,00	401,74		
JEEP														
CHEROKEE	4WD 2-4 doors	19008		85	87	x		C	1600	110		243,80	x	
CHEROKEE	4WD	19013	KJ	02	02/08			C	3360	140	14,50	329,66		x
CHEROKEE	4WD	10002/SF	KK	03/08	03/14	x	i	SF	3500	140	15,20	280,90		x
CHEROKEE	4WD	10002/C	KK	03/08	03/14	x	i	C	3500	140	15,20	337,08		x
CHEROKEE	4WD	10002/G	KK	03/08	03/14	x	i	GRIFO	3500	140	15,20	523,64		x
CHEROKEE	2-4WD, AdBlue	19021/F	KL	04/14		x	V	F	3259	125	13,80	196,10		x
CHEROKEE	2-4WD, AdBlue	19021/C	KL	04/14		x	V	C	3259	125	13,80	299,98		x
CHEROKEE	2-4WD, AdBlue	19021/VM	KL	04/14		x	V	VM	3259	125	13,80	355,10		x
COMMANDER	2-4WD	19015/F	WH	05	03/11			F	3500	140	15,60	147,34		x
COMMANDER	2-4WD	19015/C	WH	05				C	3500	140	15,60	288,32		x
COMPASS	Restyling '10, Restyling '14	19019	PK	09/06	05/17		v	C	2000	110	10,50	260,76		x
COMPASS	2-4WD, AdBlue, check D value	19022/F	MX, MP	06/17		x	v	F	1641	100	10,10	177,02		x















													
COMPASS	2-4WD, AdBlue, check D value	19022/C	MX, MP	06/17		x	v	C	1641	100	10,10	292,56	x
COMPASS	2-4WD, AdBlue, check D value	19022/VM	MX, MP	06/17		x	v	VM	1641	100	10,10	362,52	x
COMPASS	HYBRID	19025/F	MX, MP	06/20		x	v	F	1641	100	10,10	190,80	x
COMPASS	HYBRID	19025/C	MX, MP	06/20		x	v	C	1641	100	10,10	291,50	x
COMPASS	HYBRID	19025/VM	MX, MP	06/20		x	v	VM	1641	100	10,10	386,90	x
COMPASS TRAILHAWK	2-4WD, AdBlue, check D value	19024/F	MX, MP	10/18		x	v	F	1641	100	10,10	177,02	x
COMPASS TRAILHAWK	2-4WD, AdBlue, check D value	19024/C	MX, MP	10/18		x	v	C	1641	100	10,10	292,56	x
COMPASS TRAILHAWK	2-4WD, AdBlue, check D value	19024/VM	MX, MP	10/18		x	v	VM	1641	100	10,10	362,52	x
COMPASS TRAILHAWK	HYBRID, check D value	19027/F	MX, MP	07/20		x	v	F	1641	100	10,10	190,80	x
COMPASS TRAILHAWK	HYBRID, check D value	19027/C	MX, MP	07/20		x	v	C	1641	100	10,10	291,50	x
COMPASS TRAILHAWK	HYBRID, check D value	19027/VM	MX, MP	07/20		x	v	VM	1641	100	10,10	386,90	x
GLADIATOR	PICK-UP 4x4	19023/F	JT	10/19				F	2865	140	14,20	302,10	x
GLADIATOR	PICK-UP 4x4	19023/C	JT	10/19				C	2865	140	14,20	339,20	x
GLADIATOR	PICK-UP 4x4	19023/G	JT	10/19				GRIFO(C)	2865	140	14,20	439,90	x
GLADIATOR	PICK-UP 4x4	19023/SF	JT	10/19				SF(C)	2865	140	14,20	312,70	x
GLADIATOR	PICK-UP 4x4	19023/SFM	JT	10/19				SFM(C)	2865	140	14,20	445,20	x
GRAND CHEROKEE	4WD 4 doors	19010	Z	01/93	01/99			C	3500	110	14,70	279,84	x
GRAND CHEROKEE	4WD 4 doors	19014/F	W, WG, RC	01/99	06/05	x	i	F	3500	140	14,50	209,88	x
GRAND CHEROKEE	4WD 4 doors	19014/C	W, WG, RC	01/99	06/05	x	i	C	3500	140	14,50	296,80	x
GRAND CHEROKEE	4WD 4 doors	19015/F	WH	06/05	03/11		i	F	3500	140	15,60	147,34	x
GRAND CHEROKEE	4WD 4 doors	19015/C	WH	06/05	03/11		i	C	3500	140	15,60	288,32	x
GRAND CHEROKEE	4WD 4 doors, Restyling '14, no SRT, no Summit, AdBlue	19020	WK	05/11		x		VM	3500	175	16,00	337,08	x
PATRIOT	SUV, Restyling '11	19019	PK	09/06			v	C	2000	110	10,50	260,76	x
RENEGADE	2-4WD, AdBlue, Sport	19022/F	BU	10/14		x	v	F	1641	100	10,10	177,02	x
RENEGADE	2-4WD, AdBlue, Sport	19022/C	BU	10/14		x	v	C	1641	100	10,10	292,56	x
RENEGADE	2-4WD, AdBlue, Sport	19022/VM	BU	10/14		x	v	VM	1641	100	10,10	362,52	x
RENEGADE	HYBRID	19025/F	BU	06/20		x	v	F	1641	100	10,10	190,80	x
RENEGADE	HYBRID	19025/C	BU	06/20		x	v	C	1641	100	10,10	291,50	x
RENEGADE	HYBRID	19025/VM	BU	06/20		x	v	VM	1641	100	10,10	386,90	x
RENEGADE TRAILHAWK	2-4WD, AdBlue	19024/F	BU	10/14		x	v	F	1641	100	10,10	177,02	x
RENEGADE TRAILHAWK	2-4WD, AdBlue	19024/C	BU	10/14		x	v	C	1641	100	10,10	292,56	x
RENEGADE TRAILHAWK	2-4WD, AdBlue	19024/VM	BU	10/14		x	v	VM	1641	100	10,10	362,52	x
WRANGLER	4WD, Restyling '10	19017/F	JK	01/07	08/18			F	3500	170	15,40	142,04	x
WRANGLER	4WD, Restyling '10	19017/SF	JK	01/07	08/18			SF(C)	3500	170	15,40	324,36	x
WRANGLER	4WD, Restyling '10	19017/C	JK	01/07	08/18			C	3500	170	15,40	265,00	x
WRANGLER	4WD, Restyling '10	19017/G	JK	01/07	08/18			GRIFO(C)	3500	170	15,40	475,94	x
WRANGLER	4WD, Restyling '10	19018	JK	01/07	08/18	x		VM	3500	170	15,40	359,34	x
WRANGLER	JL, 4WD	19017/F	JK	09/18				F	3500	170	15,40	142,04	x















														
WRANGLER	JL, 4WD	19017/SF	JK	09/18					SF(C)	3500	170	15,40	324,36	x
WRANGLER	JL, 4WD	19017/C	JK	09/18					C	3500	170	15,40	265,00	x
WRANGLER	JL, 4WD	19017/G	JK	09/18					GRIFO(C)	3500	170	15,40	475,94	x
WRANGLER	4WD, Adblue	19018	JK	09/18		x			VM	3500	170	15,40	359,34	x
WRANGLER	HYBRID	19026	JK	09/18		x			VM	3500	170	15,40	386,90	x
WRANGLER	HYBRID	19028/F	JK	09/18					F	3500	170	15,40	254,40	x
WRANGLER	HYBRID	19028/SF	JK	09/18					SF(C)	3500	170	15,40	265,00	x
WRANGLER	HYBRID	19028/C	JK	09/18					C	3500	170	15,40	328,60	x
WRANGLER	HYBRID	19028/G	JK	09/18					GRIFO(C)	3500	170	15,40	434,60	x
KIA														
CARENS	MPV	19107/F	FG F	07/06	02/13	x	i	F	1500	75	9,10	196,10	x	x
CARENS	MPV	19107/C	FG F	07/06	02/13	x	i	C	1500	75	9,10	222,60	x	x
CARENS	MPV	19116/F	RP	03/13				F	1500	75	9,10	208,82	x	x
CARENS	MPV	19116/C	RP	03/13				C	1500	75	9,10	307,40	x	x
CARENS	MPV	19116/VM	RP	03/13				VM	1500	75	9,10	383,72	x	x
CARNIVAL	MPV	19102/F	UP	99	04/06	x	i	F	2000	75	11,40	209,88	x	x
CARNIVAL	MPV	19102	UP	99	04/06	x	i	C	2000	75	11,40	332,84	x	x
CEE'D	HATCHBACK 3-5 doors	45017/F	EDB	01/07	05/12		i	F	1500	75	8,70	184,44	x	x
CEE'D	HATCHBACK 3-5 doors	45017/C	EDB	01/07	05/12		i	C	1500	75	8,70	288,32	x	x
CEE'D	HATCHBACK 3-5 doors	45017/VM	EDB	01/07	05/12		i	VM	1500	75	8,70	365,70	x	x
CEE'D	HATCHBACK 5 doors, No GT Line	19114/F	JD	06/12	04/18	x	i	F	1500	75	8,80	184,44	x	x
CEE'D	HATCHBACK 5 doors, No GT Line	19114/C	JD	06/12	04/18	x	i	C	1500	75	8,80	307,40	x	x
CEED	HATCHBACK 5 doors, AdBlue, LPG	19119/F	CD	05/18		x	i	F	1660	90	8,90	205,64	x	x
CEED	HATCHBACK 5 doors, AdBlue, LPG	19119/C	CD	05/18		x	i	C	1660	90	8,90	332,84	x	x
CEED	HATCHBACK 5 doors, AdBlue, LPG	19119/VM	CD	05/18		x	i	VM	1660	90	8,90	355,10	x	x
XCEED	CROSSOVER, AdBlue	19119/F	CD	09/19		x	i	F	1660	90	8,90	205,64	x	x
XCEED	CROSSOVER, AdBlue	19119/C	CD	09/19		x	i	C	1660	90	8,90	332,84	x	x
XCEED	CROSSOVER, AdBlue	19119/VM	CD	09/19		x	i	VM	1660	90	8,90	355,10	x	x
XCEED	HYBRID	19121/F	CD	09/19		x	i	F	1660	90	8,90	233,20	x	x
XCEED	HYBRID	19121/C	CD	09/19		x	i	C	1660	90	8,90	302,10	x	x
XCEED	HYBRID	19121/VM	CD	09/19		x	i	VM	1660	90	8,90	365,70	x	x
CEE'D	HATCHBACK 5 doors, No GT Line	19114/VM	JD	06/12	04/18	x	i	VM	1500	75	8,80	365,70	x	x
CEE'D SPORTY WAGON	ESTATE, Dual Fuel	19106/F	EDF, EDG, EDI	09/07	08/12	x	i	F	1500	75	9,00	196,10	x	x
CEE'D SPORTY WAGON	ESTATE, Dual Fuel	19106/C	EDF, EDG, EDI	09/07	08/12	x	i	C	1500	75	9,00	298,92	x	x
CEE'D SPORTY WAGON	ESTATE, Dual Fuel	19106/VM	EDF, EDG, EDI	09/07	08/12	x	i	VM	1500	75	9,00	365,70	x	x
CEE'D SPORTY WAGON	ESTATE, Also for GT Line	19114/F	JD	09/12	06/18	x	i	F	1500	75	8,80	184,44	x	x
CEE'D SPORTY WAGON	ESTATE, Also for GT Line	19114/C	JD	09/12	06/18	x	i	C	1500	75	8,80	307,40	x	x
CEE'D SPORTY WAGON	ESTATE, Also for GT Line	19114/VM	JD	09/12	06/18	x	i	VM	1500	75	8,80	365,70	x	x
K2500		19103	SD, SE	02				C	1400	75	11,00	260,76	x	x
PICANTO	HATCHBACK	19105/F	BA	01/04	04/11	x		F	700	28	5,20	233,20	x	x
PICANTO	HATCHBACK	19105/C	BA	01/04	04/11	x		C	700	28	5,20	261,82	x	x















													
PICANTO	HATCHBACK	19112/F	TA	05/11	04/20 17			F	700	28	5,50	233,20	x
PICANTO	HATCHBACK	19112/C	TA	05/11	04/20 17			C	700	28	5,50	261,82	x
PRO-CEE'D	HATCHBACK 3 doors	45017/C	EDB	01/08	11/12		i	C	1500	75	8,70	288,32	x
PRO-CEE'D	HATCHBACK 3 doors	45017/VM	EDB	01/08	11/12		i	VM	1500	75	8,70	365,70	x
PRO-CEE'D	HATCHBACK 3 doors	45017/F	EDB	01/08	11/12		i	F	1500	75	8,70	184,44	x
RIO	HATCHBACK 3-5 doors	19113/F	UB	08/11	12/16	x	v	F	1300	80	7,60	171,72	x
RIO	HATCHBACK 3-5 doors	19113/C	UB	08/11	12/16	x	v	C	1300	80	7,60	275,60	x
RIO	HATCHBACK 3-5 doors	19113/VM	UB	08/11	12/16	x	v	VM	1300	80	7,60	355,10	x
RIO	HATCHBACK 5 doors, No GT Line, B/GPL	45025/F	YB	01/17		x	v	F	1210	75	6,90	163,24	x
RIO	HATCHBACK 5 doors, No GT Line, B/GPL	45025/C	YB	01/17		x	v	C	1210	75	6,90	265,00	x
RIO	HATCHBACK 5 doors, No GT Line, B/GPL	45025/VM	YB	01/17		x	v	VM	1210	75	6,90	344,50	x
SORENTO	4WD Restyling	19104/F	JC	08/02	09/09	x	v	F	2800	112	14,20	233,20	x
SORENTO	4WD Restyling	19104	JC	08/02	09/09	x	v	C	2800	112	14,20	318,00	x
SORENTO	4WD, without spare wheel under the panel	19110/F	XM	10/09	11/12	x		F	2500	100	13,00	202,46	x
SORENTO	4WD, without spare wheel under the panel	19110/C	XM	10/09	11/12	x		C	2500	100	13,00	307,40	x
SORENTO	4WD, without spare wheel under the panel	19110/VM	XM	10/09	11/12	x		VM	2500	100	13,00	355,10	x
SORENTO	2-4WD	19115/F	XM FL	12/12	02/15		V	F	2500	100	13,00	202,46	x
SORENTO	2-4WD	19115/C	XM FL	12/12	02/15		V	C	2500	100	13,00	307,40	x
SORENTO	2-4WD	19115/VM	XM FL	12/12	02/15		V	VM	2500	100	13,00	355,10	x
SORENTO	2-4WD	19117/F	UM	02/15	12/17	x	v	F	2621	100	13,00	192,92	x
SORENTO	2-4WD	19117/C	UM	02/15	12/17	x	v	C	2621	100	13,00	294,68	x
SORENTO	2-4WD, the towball holder remains slightly visible	19117/VM	UM	02/15	12/17	x	v	VM	2621	100	13,00	355,10	x
SOUL	MPV, Dual Fuel	19108/F	AM	01/09	01/14		i	F	1300	52	8,00	184,44	x
SOUL	MPV, Dual Fuel	19108/C	AM	01/09	01/14		i	C	1300	52	8,00	298,92	x
SOUL	MPV, Dual Fuel	19108/VM	AM	01/09	01/14		i	VM	1300	52	8,00	355,10	x
SPORTAGE	SUV 4WD 2-4 doors, no WAGON JA4?6	19101	JA, JA-2, JA-4	95	09/04			C	1800	70	10,00	305,28	x
SPORTAGE	SUV 2-4WD	45021/F	JE	11/04	07/10		i	F	1600	75	10,50	178,08	x
SPORTAGE	SUV 2-4WD	45021/C	JE	11/04	07/10		i	C	1600	75	10,50	283,02	x
SPORTAGE	SUV 2-4WD	45021/VM	JE	11/04	07/10		i	VM	1600	75	10,50	356,16	x
SPORTAGE	SUV 2-4WD	19111/F	SL	08/10	01/16	x		F	2000	80	10,80	171,72	x
SPORTAGE	SUV 2-4WD	19111/C	SL	08/10	01/16	x		C	2000	80	10,80	270,30	x
SPORTAGE	SUV 2-4WD	19111/VM	SL	08/10	01/16	x		VM	2000	80	10,80	356,16	x
SPORTAGE	SUV 2-4WD, GT-Line	45024/F	QLE	02/16	09/18			F	2440	100	11,50	178,08	x
SPORTAGE	SUV 2-4WD, GT-Line	45024/C	QLE	02/16	09/18			C	2440	100	11,50	270,30	x
SPORTAGE	SUV 2-4WD, GT-Line	45024/VM	QLE	02/16	09/18			VM	2440	100	11,50	356,16	x
SPORTAGE	SUV 2-4WD, GT-Line, AdBlue	45027/F	QLE	11/18	12/21	x	i	F	2440	100	11,50	178,08	x
SPORTAGE	SUV 2-4WD, GT-Line, AdBlue	45027/C	QLE	11/18	12/21	x	i	C	2440	100	11,50	283,02	x
SPORTAGE	SUV 2-4WD, GT-Line, AdBlue	45027/VM	QLE	11/18	12/21		i	VM	2440	100	11,50	356,16	x
SPORTAGE	SUV 2-4WD	45027/F	NQ5E	01/22		x	i	F	2440	100	11,50	178,08	x
SPORTAGE	SUV 2-4WD	45027/C	NQ5E	01/22		x	i	C	2440	100	11,50	283,02	x
SPORTAGE	SUV 2-4WD	45027/VM	NQ5E	01/22			i	VM	2440	100	11,50	356,16	x
SPORTAGE	HYBRID	45029/F	NQ5E, QLE	11/18		x	i	F	2440	100	11,50	233,20	x
SPORTAGE	HYBRID	45029/C	NQ5E, QLE	11/18		x	i	C	2440	100	11,50	312,70	x















														
SPORTAGE	HYBRID	45029/VM	NQ5E, QLE	11/18			i	VM	2440	100	11,50	402,80	x	
STONIC	CROSSOVER, No AdBlue	19118/F	YB	09/17		x	i	F	1291	75	7,20	174,90	x	
STONIC	CROSSOVER, No AdBlue	19118/C	YB	09/17		x	i	C	1291	75	7,20	291,50	x	
STONIC	CROSSOVER, No AdBlue	19118/VM	YB	09/17		x	i	VM	1291	75	7,20	339,20	x	
STONIC	HYBRID	19122/F	YB	01/21		x	i	F	1291	75	7,20	190,80	x	
STONIC	HYBRID	19122/C	YB	01/21		x	i	C	1291	75	7,20	259,70	x	
STONIC	HYBRID	19122/VM	YB	01/21		x	i	VM	1291	75	7,20	355,10	x	
VENGA	HATCHBACK	19113/F	YN	11/09		x	i	F	1300	80	7,60	171,72	x	
VENGA	HATCHBACK	19113/C	YN	11/09		x	i	C	1300	80	7,60	275,60	x	
VENGA	HATCHBACK	19113/VM	YN	11/09		x	i	VM	1300	80	7,60	355,10	x	
LADA														
NIVA	4WD, CABRIO, LPG	20007/SF	2121					SF(C)	1490	60	8,50	294,68	x	
NIVA	4WD, CABRIO, LPG	20007/C	2121					C	1490	60	8,50	253,34	x	
NIVA	4WD, CABRIO, LPG	20007/G	2121					GRIFO(C)	1490	60	8,50	430,36	x	
LANCIA														
DEDRA	Saloon, ESTATE, no 4X4	21031	835	01/95	08/99	x	v	C	1400	90		217,30	x	
DELTA	HATCHBACK	13150/F	844	09/08		x	i	F	1300	60	8,30	166,42		x
DELTA	HATCHBACK	13150/C	844	09/08		x	i	C	1300	60	8,30	275,60		x
DELTA	HATCHBACK	13150/VM	844	09/08		x	i	VM	1300	60	8,30	365,70		x
DELTA	HATCHBACK 3-5 doors, no 4X4, no HF	21036	836	93	99	x		C	1300	75	8,00	235,32	x	
KAPPA	Saloon, ESTATE, COUPÉ	21034	838	94		x		C	1500	90		231,08		x
LYBRA	Saloon, ESTATE	21037	839	01/99	07/05		i	C	1400	75	8,80	261,82		x
MUSA	MPV	13166/F	350	11/04		x	i	F	1281	60	7,30	181,26		x
MUSA	MPV	13166/C	350	11/04		x	i	C	1281	60	7,30	224,72		x
MUSA	MPV	13166/VM	350	11/04		x	i	VM	1281	60	7,30	321,18		x
PHEDRA	MPV	13137/F	179	03/02	10		i	F	1850	76	11,00	209,88		x
PHEDRA	MPV	13137/C	179	03/02	10		i	C	1850	76	11,00	295,74		x
THEMA	Saloon, ESTATE	21030	834	94		x		C	1500	91		168,54	x	
THEMA	Saloon	21041/F	LX	12		x	i	F	2121	100	11,20	215,18		x
THEMA	Saloon	21041/C	LX	12		x	i	C	2121	100	11,20	319,06		x
THEMA	Saloon	21041/VM	LX	12		x	i	VM	2121	100	11,20	360,40		x
THESIS	Saloon	21038/F	841	01/02	09/08	x	i	F	1500	75	10,00	233,20		x
THESIS	Saloon	21038/C	841	01/02	09/08	x	i	C	1500	75	10,00	288,32		x
THESIS	Saloon	21038/VM	841	01/02	09/08	x	i	VM	1500	75	10,00	361,46		x
VOYAGER	MPV, no 3.6 V6 PETROL	06055/F	RT	08		x	i	F	1600	100	10,20	184,44		x
VOYAGER	MPV, no 3.6 V6 PETROL	06055/C	RT	08		x	i	C	1600	100	10,20	288,32		x
VOYAGER	MPV, no 3.6 V6 PETROL	06055/VM	RT	08		x	i	VM	1600	100	10,20	361,46		x
Y	HATCHBACK	13123	840 A	96	03	x		C	1100	70	6,50	227,90	x	
YPSILON	HATCHBACK 3 doors	13166/F	843	10/03	05/11	x	i	F	1281	60	7,30	181,26		x
YPSILON	HATCHBACK 3 doors	13166/C	843	10/03	05/11	x	i	C	1281	60	7,30	224,72		x
YPSILON	HATCHBACK 3 doors	13166/VM	843	10/03	05/11	x	i	VM	1281	60	7,30	321,18		x
YPSILON	HATCHBACK, no Natural Power, check towing capacity	13162/F	312	06/11		x	i	F	1000	60	6,70	139,92		x
YPSILON	HATCHBACK, no Natural Power, check towing capacity	13162/C	312	06/11		x	i	C	1000	60	6,70	217,30		x















													
YPSILON	HATCHBACK, no Natural Power, check towing capacity	13162/VM	312	06/11		x	i	VM	1000	60	6,70	338,14	x
ZETA	MPV	13133/F	220	94	2			F	1300	60	10,50	209,88	x
ZETA	MPV	13133	220	94	02			C	1300	60	10,50	268,18	x
LAND ROVER													
DEFENDER	90 4WD, no PETROL	03027/1C	LD	98	08/20			C	3500	150	16,50	316,94	x
DEFENDER	90 4WD, no PETROL	03027/1SF	LD	98	08/20			SF	3500	150	16,50	299,98	x
DEFENDER	90 4WD, no PETROL	03027/1G	LD	98	08/20			GRIFO	3500	150	16,50	471,70	x
DEFENDER	90 4WD 2doors, PETROL	03027/2C CC	LD 90 HT CAR	83	08/20			C	3500	150	16,50	316,94	x
DEFENDER	90 4WD 2doors, PETROL	03027/2SF CC	LD 90 HT CAR	83	08/20			SF	3500	150	16,50	299,98	x
DEFENDER	90 4WD 2doors, PETROL	03027/2G CC	LD 90 HT CAR	83	08/20			GRIFO	3500	150	16,50	471,70	x
DEFENDER	110-110HC PU-130 4WD	03027/2C	LD	98	08/20			C	3500	150	16,50	278,78	x
DEFENDER	110 4WD, no 110 HC PU E 130	03027/2SF	LD	98	08/20			SF	3500	150	16,50	299,98	x
DEFENDER	110-110HC PU-130 4WD	03027/2G	LD	98	08/20			GRIFO	3500	150	16,50	471,70	x
DEFENDER III	type L663, HYBRID	03038/SF	LE	09/19		x	v	SF	3766	200	17,20	260,00	x
DEFENDER III	type L663, HYBRID	03038/G	LE	09/19		x	v	G	3766	200	17,20	410,00	x
DEFENDER III	type L663, HYBRID	03038/SFM	LE	09/19		x	v	SFM	3766	200	17,20	480,00	x
DISCOVERY I	4WD	03015	LJ	90	97			C	3500	150		254,40	x
DISCOVERY II	4WD, not for Self Leveling	03023	LT	97	12/04			C	3500	150	15,80	297,86	x
DISCOVERY II	4WD, not for Self Leveling	03023/F	LT	97	12/04			F	3500	150	15,80	181,26	x
DISCOVERY V	4WD	03036/F	LR	09/16		x	i	F	3562	150	16,70	265,00	x
DISCOVERY SPORT	2-4WD, without spare wheel under the panel	03029/F	LC	02/15	07/19	x	v	F	2640	150	13,00	244,86	x
DISCOVERY SPORT	2-4WD, without spare wheel under the panel	03029/C	LC	02/15	07/19	x	v	C	2640	150	13,00	338,14	x
DISCOVERY SPORT	2-4WD, 5+2 with spare wheel under the panel	03033/F	LC	02/15	07/19	x	v	F	2640	150	13,00	256,52	x
DISCOVERY SPORT	2-4WD, 5+2 with spare wheel under the panel	03033/C	LC	02/15	07/19	x	v	C	2640	150	13,00	309,52	x
DISCOVERY SPORT	2-4WD, 5+2 with spare wheel under the panel	03033/VM	LC	02/15	07/19	x	v	VM	2640	150	13,00	408,10	x
DISCOVERY SPORT	2-4WD, 5 seats without spare wheel under the panel	03034/F	LC	08/19		x	v	F	2629	150	12,80	302,10	x
DISCOVERY SPORT	2-4WD, 5 seats without spare wheel under the panel	03034/C	LC	08/19		x	v	C	2629	150	12,80	355,10	x
DISCOVERY SPORT	2-4WD, 5 seats without spare wheel under the panel	03034/VM	LC	08/19		x	v	VM	2629	150	12,80	466,40	x
DISCOVERY SPORT	HYBRID, 5 seats without spare wheel under the panel	03037/F	LC	08/19		x	v	F	2629	150	12,80	275,60	x
DISCOVERY SPORT	HYBRID, 5 seats without spare wheel under the panel	03037/C	LC	08/19		x	v	C	2629	150	12,80	339,20	x
DISCOVERY SPORT	HYBRID, 5 seats without spare wheel under the panel	03037/VM	LC	08/19		x	v	VM	2629	150	12,80	434,60	x
FREELANDER	SUV 2-4WD 2-4 doors (3-5 doors), CABRIO 3 doors	03024/C	LN	01/98	01/07			C	2000	140	11,00	261,82	x
FREELANDER II	SUV 4WD	03026/F	LF	03/07	10/12	x	v	F	2000	150	11,30	160,06	x
FREELANDER II	SUV 4WD	03026/C	LF	03/07	10/12	x	v	C	2000	150	11,30	270,30	x
FREELANDER II	SUV 4WD	03026/VM	LF	03/07	10/12	x	v	VM	2000	150	11,30	360,40	x















													
FREELANDER II	SUV 4WD	03026/SF	LF	03/07	10/12	x	v	SF(C)	2000	150	11,30	326,48	x
FREELANDER II	SUV 4WD	03026/G	LF	03/07	10/12	x	v	GRIFO	2000	150	11,30	479,12	x
FREELANDER II FL	SUV 4WD	03026/F	LF	11/12		x	v	F	2000	150	11,30	160,06	x
FREELANDER II FL	SUV 4WD	03026/C	LF	11/12		x	v	C	2000	150	11,30	270,30	x
FREELANDER II FL	SUV 4WD	03026/VM	LF	11/12		x	v	VM	2000	150	11,30	360,40	x
FREELANDER II FL	SUV 4WD	03026/SF	LF	11/12		x	v	SF(C)	2000	150	11,30	326,48	x
FREELANDER II FL	SUV 4WD	03026/G	LF	11/12		x	v	GRIFO	2000	150	11,30	479,12	x
RANGE ROVER	4WD	03016	LH		95			C	1820	75		255,46	x
RANGE ROVER	4WD	03020	LP	95	02	x		C	3500	150	15,80	275,60	x
RANGE ROVER	4WD, no SPORT	03025	LM	01/02	12	x		SF(C)	3500	150	16,50	358,28	x
RANGE ROVER EVOQUE	SUV 2-4WD, also Restyling '14	03028/F	LV	09/11	12/18	x	i	F	2000	150	10,65	171,72	x
RANGE ROVER EVOQUE	SUV 2-4WD, also Restyling '14	03028/C	LV	09/11	12/18	x	i	C	2000	150	10,65	283,02	x
RANGE ROVER EVOQUE	SUV 2-4WD, also Restyling '14	03028/VM	LV	09/11	12/18	x	i	VM	2000	150	10,65	367,82	x
RANGE ROVER EVOQUE COUPÉ	COUPÉ	03028/F	LV	09/11	12/18	x	i	F	2000	150	10,65	171,72	x
RANGE ROVER EVOQUE COUPÉ	COUPÉ	03028/C	LV	09/11	12/18	x	i	C	2000	150	10,65	283,02	x
RANGE ROVER EVOQUE COUPÉ	COUPÉ	03028/VM	LV	09/11	12/18	x	i	VM	2000	150	10,65	367,82	x
RANGE ROVER EVOQUE	SUV 2-4WD	03035/F	LZ	12/18		x	i	F	2095	130	11,50	296,80	x
RANGE ROVER EVOQUE	SUV 2-4WD	03035/C	LZ	12/18		x	i	C	2095	130	11,50	355,10	x
RANGE ROVER EVOQUE	SUV 2-4WD	03035/VM	LZ	12/18		x	i	VM	2095	130	11,50	418,70	x
RANGE ROVER SPORT	SUV 4WD	03032/C	LW	08/13		x	v	C	3545	200	16,50	286,20	x
RANGE ROVER SPORT	SUV 4WD, No Bumper cut disassembling the door, visible cut cutting the door	03032/VM	LW	08/13		x		VM	3545	200	16,50	386,90	x
RANGE ROVER IV (L405)	SUV 4WD, Vogue, No Hybrid	03031/C	LG	08/12		x		C	3545	200	16,00	332,84	x
RANGE ROVER IV (L405)	SUV 4WD, Vogue, No Hybrid	03031/VM	LG	08/12		x		VM	3545	200	16,00	408,10	x
RANGE ROVER VELAR	SUV 4WD	03030/F	LY	07/17		x	v	F	2691	100	13,00	239,56	x
RANGE ROVER VELAR	SUV 4WD	03030/C	LY	07/17		x	v	C	2691	100	13,00	332,84	x
RANGE ROVER VELAR	SUV 4WD, No Bumper cut disassembling the door, visible cut cutting the door	03030/VM	LY	07/17		x		VM	2691	100	13,00	401,74	x
RANGE ROVER VELAR	SUV 4WD, HYBRID	03039/F	LY	09/20		x	v	F	2691	100	13,00	291,50	x
RANGE ROVER VELAR	SUV 4WD, HYBRID	03039/C	LY	09/20		x	v	C	2691	100	13,00	365,70	x
RANGE ROVER VELAR	SUV 4WD, No Bumper cut disassembling the door, visible cut cutting the door, HYBRID	03039/VM	LY	09/20		x		VM	2691	100	13,00	418,70	x
MAHINDRA													
GOA	PICK-UP 4WD 2-4 doors	21201/C	S5TX,S5TZ	06	07/18			C	3000	120	15,85	338,14	x
GOA	PICK-UP 4WD 2-4 doors	21201/SF	S5TX,S5TZ	06	07/18			SF(C)	3000	120	15,85	324,36	x
GOA	PICK-UP 4WD 2-4 doors	21201/G	S5TX,S5TZ	06	07/18			GRIFO(C)	3000	120	15,85	502,44	x















														
MASERATI														
LEVANTE	4WD, Gransport	21401/F	M156			x	v	F	2890	135	14,20	244,86		x
LEVANTE	4WD, Gransport	21401/C	M156	04/16		x	v	C	2890	135	14,20	339,20		x
LEVANTE	4WD, Gransport, invisible bumper cut with original	21401/VM	M156	04/16		x		VM	2890	135	14,20	429,30		x
LEVANTE	GT Hybrid	21402/F	M156	06/21		x	v	F	2890	135	14,20	265,00		x
LEVANTE	GT Hybrid	21402/C	M156	06/21		x	v	C	2890	135	14,20	371,00		x
LEVANTE	GT Hybrid	21402/VM	M156	06/21		x		VM	2890	135	14,20	471,70		x
MAZDA														
2	HATCHBACK 3-5 doors	22004/F	DE	11/07	07/14	x		F	900	50	6,00	171,72		x
2	HATCHBACK 3-5 doors	22004/C	DE	11/07	07/14	x		C	900	50	6,00	260,76		x
2	HATCHBACK 3-5 doors	22004/VM	DE	11/07	07/14	x		VM	900	50	6,00	354,04		x
2	MPV	22001/F	DY	05/03	10/07			F	900	50	6,00	208,82	x	
2	MPV	22001/C	DY	05/03	10/07			C	900	50	6,00	314,82	x	
3	HATCHBACK 5 doors, Restyling, no SPORT	22002/F	BK, BL	10/03	10/13	x	i	F	1300	75	8,40	166,42		x
3	HATCHBACK 5 doors, Restyling, no SPORT	22002/C	BK, BL	10/03	10/13	x	i	C	1300	75	8,40	283,02		x
3	HATCHBACK 5 doors, Restyling, no SPORT	22002/VM	BK, BL	10/03	10/13	x	i	VM	1300	75	8,40	339,20		x
3 SPORT	HATCHBACK 5 doors	22002S/F	BK	10/03	08/13	x		F	1300	75	8,40	166,42		x
3 SPORT	HATCHBACK 5 doors	22002S/C	BK	10/03	08/13	x		C	1300	75	8,40	283,02		x
3 SPORT	HATCHBACK 5 doors	22002S/VM	BK	10/03	08/13	x		VM	1300	75	8,40	339,20		x
6	Saloon, no AdBlue	22007/F	GJ, GH	02/13		x	i	F	1800	90	10,80	190,80		x
6	Saloon, no AdBlue	22007/C	GJ, GH	02/13		x	i	C	1800	90	10,80	299,98		x
6	Saloon, no AdBlue	22007/VM	GJ, GH	02/13		x	i	VM	1800	90	10,80	365,70		x
6	ESTATE, no Saloon	22005/F	GH	08	09/12	x	i	F	1800	75	10,00	220,48		x
6	ESTATE, no Saloon	22005/C	GH	08	09/12	x	i	C	1800	75	10,00	275,60		x
6	ESTATE, no Saloon	22005/VM	GH	08	09/12	x	i	VM	1800	75	10,00	368,88		x
6 WAGON	ESTATE, no AdBlue	22007/F	GJ, GH	10/12		x	i	F	1800	90	10,80	190,80		x
6 WAGON	ESTATE, no AdBlue	22007/C	GJ, GH	10/12		x	i	C	1800	90	10,80	299,98		x
6 WAGON	ESTATE, no AdBlue	22007/VM	GJ, GH	10/12		x	i	VM	1800	90	10,80	365,70		x
6 WAGON	ESTATE, Restyling	22003/F	GY, GG1, GG/GY	06/02	08	x	v	F	1800	75	9,70	220,48		x
6 WAGON	ESTATE, Restyling	22003/C	GY, GG1, GG/GY	06/02	08	x	v	C	1800	75	9,70	289,38		x
6 WAGON	ESTATE, Restyling	22003/VM	GY, GG1, GG/GY	06/02	08	x	v	VM	1800	75	9,70	349,80		x
B2500	PICK-UP 4WD	14081/SF	UN, UE, UF	96	12	x		SF	3000	112	15,00	275,60	x	
B2500	PICK-UP 4WD	14081/G	UN, UE, UF	96	12	x		GRIFO	3000	112	15,00	456,86	x	
BT50	PICK-UP 4WD	14081/SF	UN, UE, UF	96	12	x		SF	3000	112	15,00	275,60	x	
BT50	PICK-UP 4WD	14081/G	UN, UE, UF	96	12	x		GRIFO	3000	112	15,00	456,86	x	
CX-3	2-4WD	22008/F	DJ1	06/15		x		F	1480	75	8,00	175,96		x
CX-3	2-4WD	22008/C	DJ1	06/15		x		C	1480	75	8,00	299,98		x
CX-3	2-4WD	22008/VM	DJ1	06/15		x		VM	1480	75	8,00	383,72		x
CX-5	2-4WD, Restyling '17, AdBlue	22006/F	KE, GH, KF	02/12		x	i	F	2100	88	10,70	202,46		x
CX-5	2-4WD, Restyling '17, AdBlue	22006/C	KE, GH, KF	02/12		x	i	C	2100	88	10,70	312,70		x
CX-5	2-4WD, Restyling '17, AdBlue	22006/VM	KE, GH, KF	02/12		x	i	VM	2100	88	10,70	402,80		x
MERCEDES														
124	ESTATE	23025	124				i	C	1650	75		262,88	x	
190	Saloon, large bumper new type	23021	201	88	01/93	x	v	C	1200	75		301,04	x	















														
463, G	4WD	23017	463		06/15				C	2000	120		243,80	x
A CLASS	MPV 5 doors SHORT and LONG	23031	168	10/97	12/03	x	i		C	1000	50	5,90	248,04	x
A CLASS	MPV 3-5 doors	23041/F	169	09/04	08/12	x	i		F	1500	70	8,50	208,82	x
A CLASS	MPV 3-5 doors	23041/C	169	09/04	08/12	x	i		C	1500	70	8,50	288,32	x
A CLASS	MPV 3-5 doors	23041/VM	169	09/04	08/12	x	i		VM	1500	70	8,50	361,46	x
A CLASS	HATCHBACK 5 doors, no PREMIUM, no sport AMG	23052/F	176, 245	09/12	04/18	x			F	1815	75	9,40	184,44	x
A CLASS	HATCHBACK 5 doors, no PREMIUM, no sport AMG	23052/C	176, 245	09/12	04/18	x			C	1815	75	9,40	294,68	x
A CLASS	HATCHBACK 5 doors, no PREMIUM, no sport AMG	23052/VM	176, 245	09/12	04/18	x			VM	1815	75	9,40	367,82	x
A CLASS	HATCHBACK 5 doors, AMG	23058/F	F2A	05/18		x	v		F	2143	75	10,15	209,88	x
A CLASS	HATCHBACK 5 doors, AMG	23058/C	F2A	05/18		x	v		C	2143	75	10,15	314,82	x
A CLASS	HATCHBACK 5 doors, AMG	23058/VM	F2A	05/18		x	v		VM	2143	75	10,15	415,52	x
A CLASS	HYBRID	23064/F	F2A	05/18		x	v		F	2143	75	10,15	233,20	x
A CLASS	HYBRID	23064/C	F2A	05/18		x	v		C	2143	75	10,15	323,30	x
A CLASS	HYBRID	23064/VM	F2A	05/18		x	v		VM	2143	75	10,15	402,80	x
B CLASS	MPV	23041/F	245	03/05	09/11	x	i		F	1500	70	8,50	208,82	x
B CLASS	MPV	23041/C	245	03/05	09/11	x	i		C	1500	70	8,50	288,32	x
B CLASS	MPV	23041/VM	245	03/05	09/11	x	i		VM	1500	70	8,50	361,46	x
B CLASS	MPV	23052/F	245, 246	10/11	02/19	x			F	1815	75	9,40	184,44	x
B CLASS	MPV	23052/C	245, 246	10/11	02/19	x			C	1815	75	9,40	294,68	x
B CLASS	MPV	23052/VM	245, 246	10/11	02/19	x			VM	1815	75	9,40	367,82	x
B CLASS	MPV	23058/F	F2B	03/19		x	v		F	2143	75	10,15	209,88	x
B CLASS	MPV	23058/C	F2B	03/19		x	v		C	2143	75	10,15	314,82	x
B CLASS	MPV	23058/VM	F2B	03/19		x	v		VM	2143	75	10,15	415,52	x
C CLASS	Saloon, ESTATE	23035/F	HO,202,208	10/93	02/01				F	1575	75	9,00	198,22	x
C CLASS	Saloon, ESTATE	23035	HO,202,208	10/93	02/01				C	1575	75	9,00	308,46	x
C CLASS	Saloon, no SPORT COUPÈ, no AMG	23053/F	203 R0	06/00	09/07	x			F	1914	75	9,70	226,84	x
C CLASS	Saloon, no SPORT COUPÈ, no AMG	23053/C	203 R0	06/00	09/07	x			C	1914	75	9,70	303,16	x
C CLASS	Saloon, no SPORT COUPÈ, no AMG	23053/VM	203 R0	06/00	09/07	x			VM	1914	75	9,70	363,58	x
C CLASS	Saloon	23046/F	204, 204K	03/07	02/14	x	i		F	1800	115	10,60	239,56	x
C CLASS	Saloon	23046/C	204, 204K	03/07	02/14	x	i		C	1800	115	10,60	338,14	x
C CLASS	Saloon	23046/VM	204, 204K	03/07	02/14	x	i		VM	1800	115	10,60	408,10	x
C CLASS	Saloon, ESTATE,W205, AdBlue, no AMG	23054/F	204	03/14	03/21	x			F	2330	75	11,00	183,38	x
C CLASS	Saloon, ESTATE,W205, AdBlue, no AMG	23054/C	204	03/14	03/21	x			C	2330	75	11,00	303,16	x
C CLASS	Saloon, ESTATE,W205, AdBlue, no AMG	23054/VM	204	03/14	03/21	x			VM	2330	75	11,00	363,58	x
C CLASS	COUPE'	23046/F	204, 204K	11	02/14	x	i		F	1800	115	10,60	239,56	x
C CLASS	COUPE'	23046/C	204, 204K	11	02/14	x	i		C	1800	115	10,60	338,14	x
C CLASS	COUPE'	23046/VM	204, 204K	11	02/14	x	i		VM	1800	115	10,60	408,10	x
C CLASS	ESTATE, no SPORT COUPÈ, no AMG	23053/F	203 KR2	06/00	09/07	x			F	1914	75	9,70	226,84	x
C CLASS	ESTATE, no SPORT COUPÈ, no AMG	23053/C	203 KR2	06/00	09/07	x			C	1914	75	9,70	303,16	x
C CLASS	ESTATE, no SPORT COUPÈ, no AMG	23053/VM	203 KR2	06/00	09/07	x			VM	1914	75	9,70	363,58	x
C CLASS	ESTATE, AMG	23046/F	204, 204K	09/07	02/14	x	i		F	1800	115	10,60	239,56	x
C CLASS	ESTATE, AMG	23046/C	204, 204K	09/07	02/14	x	i		C	1800	115	10,60	338,14	x
C CLASS	ESTATE, AMG	23046/VM	204, 204K	09/07	02/14	x	i		VM	1800	115	10,60	408,10	x
CITAN	MPV, VAN	31102/F	FW, KW, KX, FX	10/12	08/21				F	1355	75	8,00	184,44	x
CITAN	MPV, VAN	31102/C	FW, KW, KX, FX	10/12	08/21				C	1355	75	8,00	291,50	x

















													
CITAN	MPV, VAN	31102/VM	FW, KW, KX, FX	10/12	08/21			VM	1355	75	8,00	412,34	x
CITAN	MPV, VAN	31113/1F	MFK	09/21		x	i	F	1737	90	9,60	206,70	x
CITAN	MPV, VAN	31113/1C	MFK	09/21		x	i	C	1737	90	9,60	280,90	x
CITAN	MPV, VAN	31113/1VM	MFK	09/21		x	i	VM	1737	90	9,60	365,70	x
CLA	Saloon, COUPÈ	23052/F	117, 117?????, 117?????, 117????, 245	04/13	03/19	x		F	1815	75	9,40	184,44	x
CLA	Saloon, COUPÈ	23052/C	117, 117?????, 117?????, 117????, 245	04/13	03/19	x		C	1815	75	9,40	294,68	x
CLA	Saloon, COUPÈ	23052/VM	117, 117?????, 117?????, 117????, 245	04/13	03/19	x		VM	1815	75	9,40	367,82	x
CLK	COUPÈ, CABRIO, no 430CLK, no AMG	23035/F	208	06/97	12/04			F	1575	75	9,00	198,22	x
CLK	COUPÈ, CABRIO, no 430CLK, no AMG	23035	208	06/97	12/04			C	1575	75	9,00	308,46	x
CLK	COUPÈ, no CABRIO, no 430CLK, no AMG	23037/F	209	05/02	06/05	x	i	F	1500	75	9,50	244,86	x
CLK	COUPÈ, no CABRIO, no 430CLK, no AMG	23037/C	209	05/02	06/05	x	i	C	1500	75	9,50	326,48	x
E CLASS	Saloon, while stock lasts	23023	210, J0	06/95	01/02	x		C	1900	76	10,67	272,42	x
E CLASS	Saloon, no AMG	23036/F	211	01/02	02/09	x		F	1900	75	11,20	220,48	x
E CLASS	Saloon, no AMG	23036/C	211	01/02	02/09	x		C	1900	75	11,20	301,04	x
E CLASS	Saloon, AMG bumper	23051/F	212, 212K	09	03/16	x		F	2100	84	11,60	220,48	x
E CLASS	Saloon, AMG bumper	23051/C	212, 212K	09	03/16	x		C	2100	84	11,60	329,66	x
E CLASS	Saloon, AMG bumper	23051/VM	212, 212K	09	03/16	x		VM	2100	84	11,60	417,64	x
E CLASS	Saloon, 4MATIC	23057/F	R1ES	04/16		x	i	F	2285	115	11,60	181,26	x
E CLASS	Saloon, 4MATIC	23057/C	R1ES	04/16		x	i	C	2285	115	11,60	291,50	x
E CLASS	Saloon, 4MATIC	23057/VM	R1ES	04/16		x	i	VM	2285	115	11,60	344,50	x
E CLASS	CABRIO, AMG bumper	23050/F	207L	09		x	v	F	1800	75	11,30	220,48	x
E CLASS	CABRIO, AMG bumper	23050/C	207L	09		x	v	C	1800	75	11,30	313,76	x
E CLASS	CABRIO, AMG bumper	23050/VM	207L	09		x	v	VM	1800	75	11,30	435,66	x
E CLASS	COUPÈ', AMG bumper	23050/F	207L	09	01/17	x	v	F	1800	75	11,30	220,48	x
E CLASS	COUPÈ', AMG bumper	23050/C	207L	09	01/17	x	v	C	1800	75	11,30	313,76	x
E CLASS	COUPÈ', AMG bumper	23050/VM	207L	09	01/17	x	v	VM	1800	75	11,30	435,66	x
E CLASS	ESTATE	23030/F	210K	96	01/02		v	F	2100	84	11,70	181,26	x
E CLASS	ESTATE	23030	210K	96	01/02		v	C	2100	84	11,70	284,08	x
E CLASS	ESTATE	23038/F	211K	03/02	04/09	x		F	2100	84	11,70	220,48	x
E CLASS	ESTATE	23038/C	211K	03/02	04/09	x		C	2100	84	11,70	313,76	x
E CLASS	ESTATE	23038/VM	211K	03/02	04/09	x		VM	2100	84	11,70	435,66	x
E CLASS	ESTATE, AMG bumper	23051/F	212, 212K	10	11/16	x		F	2100	84	11,60	220,48	x
E CLASS	ESTATE, AMG bumper	23051/C	212, 212K	10	11/16	x		C	2100	84	11,60	329,66	x
E CLASS	ESTATE, AMG bumper	23051/VM	212, 212K	10	11/16	x		VM	2100	84	11,60	417,64	x
E CLASS	ESTATE, 4MATIC	23057/F	R1ES	12/16		x	i	F	2285	115	11,60	181,26	x
E CLASS	ESTATE, 4MATIC	23057/C	R1ES	12/16		x	i	C	2285	115	11,60	291,50	x
E CLASS	ESTATE, 4MATIC	23057/VM	R1ES	12/16		x	i	VM	2285	115	11,60	344,50	x
E CLASS	ESTATE, 4MATIC, AllTerrain	23057/F	R1ES	01/17		x	i	F	2285	115	11,60	181,26	x
E CLASS	ESTATE, 4MATIC, AllTerrain	23057/C	R1ES	01/17		x	i	C	2285	115	11,60	291,50	x
E CLASS	ESTATE, 4MATIC, AllTerrain	23057/VM	R1ES	01/17		x	i	VM	2285	115	11,60	344,50	x
GL	SUV 4WD	23047/GLF	164G	09/06	12	x	i	F	3500	140	16,60	233,20	x
GL	SUV 4WD	23047/GL	164G	09/06	12	x	i	VM	3500	140	16,60	390,08	x















													
GL	SUV 4WD	23047/GL1 2	166	12	12/15	x		VM	3500	140	16,60	390,08	x
GLA	also 4Matic, no AMG	23052G/F	117, 176, 245, 246	03/14	12/19	x	v	F	1815	75	9,60	147,34	x
GLA	also 4Matic, no AMG	23052G/C	117, 176, 245, 246	03/14	12/19	x	v	C	1815	75	9,60	258,64	x
GLA	also 4Matic, no AMG	23052G/VM	117, 176, 245, 246	03/14	12/19	x	v	VM	1815	75	9,60	365,70	x
GLA	H247, SUV, check D value	23060/F	F2B	01/20		x	v	F	2143	75	10,15	209,88	x
GLA	H247, SUV, check D value	23060/C	F2B	01/20		x	v	C	2143	75	10,15	314,82	x
GLA	H247, SUV, check D value	23060/VM	F2B	01/20		x	v	VM	2143	75	10,15	386,90	x
GLA	EQ POWER (HYBRID), check D value	23063/F	F2B	01/20		x	v	F	2143	75	10,15	231,08	x
GLA	EQ POWER (HYBRID), check D value	23063/C	F2B	01/20		x	v	C	2143	75	10,15	336,02	x
GLA	EQ POWER (HYBRID), check D value	23063/VM	F2B	01/20		x	v	VM	2143	75	10,15	408,10	x
GLB	X247, SUV, check D value	23060/F	F2B	01/20		x	v	F	2143	75	10,15	209,88	x
GLB	X247, SUV, check D value	23060/C	F2B	01/20		x	v	C	2143	75	10,15	314,82	x
GLB	X247, SUV, check D value	23060/VM	F2B	01/20		x	v	VM	2143	75	10,15	386,90	x
GLC	4WD, COUPÉ, AdBlue, AMG	23056/F	204, 253	09/15	05/22	x	v	F	2920	100	13,20	169,60	x
GLC	4WD, COUPÉ, AdBlue, AMG	23056/C	204, 253	09/15	05/22	x	v	C	2920	100	13,20	291,50	x
GLC	4WD, COUPÉ, AdBlue, AMG	23056/VM	204, 253	09/15	05/22	x	v	VM	2920	100	13,20	358,28	x
GLC	HYBRID	23061/F	204, 253	09/15	05/22	x	v	F	2920	100	13,20	243,80	x
GLC	HYBRID	23061/C	204, 253	09/15	05/22	x	v	C	2920	100	13,20	328,60	x
GLC	HYBRID	23061/VM	204, 253	09/15	05/22	x	v	VM	2920	100	13,20	424,00	x
GLE	SUV 2-4WD, COUPE'	23047/ML1 1F	166, 292	03/15	04/19	x	i	F	3500	140	16,60	274,54	x
GLE	SUV 2-4WD, COUPE'	23047/ML1 1	166, 292	03/15	04/19	x	i	VM	3500	140	16,60	390,08	x
GLE	SUV 4WD, COUPÉ, AdBlue	23059/F	H1GLE	05/19		x	i	F	3676	140	16,50	258,64	x
GLE	SUV 4WD, COUPÉ, AdBlue	23059/C	H1GLE	05/19		x	i	C	3676	140	16,50	344,50	x
GLE	SUV 4WD, COUPÉ, AdBlue	23059/VM	H1GLE	05/19		x	i	VM	3676	140	16,50	424,00	x
GLE	HYBRID	23062/F	H1GLE	05/19		x	i	F	3676	140	16,50	258,64	x
GLE	HYBRID	23062/C	H1GLE	05/19		x	i	C	3676	140	16,50	344,50	x
GLE	HYBRID	23062/VM	H1GLE	05/19		x	i	VM	3676	140	16,50	424,00	x
GLK	SUV 4WD, check D value	23048/F	MB204X	10/08		x	v	F	2000	80	11,30	220,48	x
GLK	SUV 4WD, check D value	23048/C	MB204X	10/08		x	v	C	2000	80	11,30	298,92	x
GLK	SUV 4WD, check D value	23048/VM	MB204X	10/08		x	v	VM	2000	80	11,30	390,08	x
GLS	SUV 4WD	23047/GL1 2	166	01/16	04/20 19	x		VM	3500	140	16,60	390,08	x
GLS	SUV	23059/F	H1GLE	05/19		x	i	F	3676	140	16,50	258,64	x
GLS	SUV	23059/C	H1GLE	05/19		x	i	C	3676	140	16,50	344,50	x
GLS	SUV	23059/VM	H1GLE	05/19		x	i	VM	3676	140	16,50	424,00	x
ML	SUV 4WD, AMG	23047/MLF	164	07/05	10/11	x	i	F	3500	135	16,60	233,20	x
ML	SUV 4WD, AMG	23047/ML	164	07/05	10/11	x	i	VM	3500	135	16,60	390,08	x
ML	SUV 4WD ON VERSION 250 BLUETEC CHECK IF IT IS POSSIBLE TO TOW	23047/ML1 1F	166	11/11		x	i	F	3500	140	16,60	274,54	x
ML	SUV 4WD ON VERSION 250 BLUETEC CHECK IF IT IS POSSIBLE TO TOW	23047/ML1 1	166	11/11		x	i	VM	3500	140	16,60	390,08	x
R CLASS	MPV	23045	251	12/06		x	i	VM	2100	85	12,60	407,04	x















														
SPRINTER	VAN, PICK UP, max total weight kg 3.900, model with platform, no rear twin wheels	23043/SF	906, 2EC, 2EK	06/06	06/2018				SF	2800	120	16,00	251,22	x
SPRINTER	VAN, PICK UP, max total weight kg 3.900, model with platform, no rear twin wheels	23043/G	906, 2EC, 2EK	06/06	06/2018				GRIFO	2800	120	16,00	463,22	x
SPRINTER	VAN, PICK UP, max total weight kg 3.900, model with platform, no rear twin wheels	23043/SF	906, 2EC, 2EK	07/18					SF	2800	120	16,00	251,22	x
SPRINTER	VAN, PICK UP, max total weight kg 3.900, model with platform, no rear twin wheels	23043/G	906, 2EC, 2EK	07/18					GRIFO	2800	120	16,00	463,22	x
VIANO	MPV	23044/F	639, MB639	10/03	08/14	x	i	F	2500	150	13,50	178,08	x	
VIANO	MPV	23044/C	639, MB639	10/03	08/14	x	i	C	2500	150	13,50	287,26	x	
VIANO	MPV	23055/SF	639, MB639	09/14		x	v	SF	2600	100	14,30	251,22	x	
VIANO	MPV	23055/G	639, MB639	09/14		x	v	G	2600	100	14,30	463,22	x	
VITO	VAN, no model with parking sensors	23026/F	108, 110, 112, 113, 638,Y	01/96	09/03	x	i	F	2000	75	12,00	233,20	x	
VITO	VAN, no model with parking sensors	23026	108, 110, 112, 113, 638,Y	01/96	09/03	x	i	C	2000	75	12,00	254,40	x	
VITO	VAN	23044/F	639, MB639	10/03	08/14	x	i	F	2500	150	13,50	178,08	x	
VITO	VAN	23044/C	639, MB639	10/03	08/14	x	i	C	2500	150	13,50	287,26	x	
VITO	VAN	23055/SF	639, MB639	09/14		x	v	SF	2600	100	14,30	251,22	x	
VITO	VAN	23055/G	639, MB639	09/14		x	v	G	2600	100	14,30	463,22	x	
X CLASS	PICK-UP 2-4WD	26032/SF	470	01/17				SF	3712	140	17,00	221,54	x	
X CLASS	PICK-UP 2-4WD	26032/G	470	01/17				G	3712	140	17,00	326,48	x	
X CLASS	PICK-UP 2-4WD	26032/SFM	470	01/17				SFM	3712	140	17,00	376,30	x	
MINI														
CLUBMAN	R55 ESTATE 3-5 doors, no Cooper S, no spare wheel, check towing capacity	11002/F	UKL-K, MINI N	11/07	09/15	x		F	750	50	6,50	184,44	x	
CLUBMAN	R55 ESTATE 3-5 doors, no Cooper S, no spare wheel, check towing capacity	11002/C	UKL-K, MINI N	11/07	09/15	x		C	750	50	6,50	307,40	x	
CLUBMAN	R55 ESTATE 3-5 doors, no Cooper S, no spare wheel, check towing capacity	11002/VM	UKL-K, MINI N	11/07	09/15	x		VM	750	50	6,50	390,08	x	
CLUBMAN	F54 ESTATE, no Pack JCW	06036/F	UKL-L, FMK	10/15		x		F	2086	80	10,70	169,60	x	
CLUBMAN	F54 ESTATE, no Pack JCW	06036/C	UKL-L, FMK	10/15		x		C	2086	80	10,70	286,20	x	
CLUBMAN	F54 ESTATE, no Pack JCW	06036/VM	UKL-L, FMK	10/15		x		VM	2086	80	10,70	355,10	x	
COOPER	R56 Saloon 3 doors, no Cooper S, no spare wheel, check towing capacity	11001/F	VKL-L, MINI N	11/06	02/14	x		F	750	50	6,00	184,44	x	
COOPER	R56 Saloon 3 doors, no Cooper S, no spare wheel, check towing capacity	11001/C	VKL-L, MINI N	11/06	02/14	x		C	750	50	6,00	294,68	x	
COOPER	R56 Saloon 3 doors, no Cooper S, no spare wheel, check towing capacity	11001/VM	VKL-L, MINI N	11/06	02/14	x		VM	750	50	6,00	390,08	x	
COOPER	3-5 doors, check towing capacity	11004/F	UKL-L	03/14		x	V	F	1000	75	6,60	184,44	x	
COOPER	3-5 doors, check towing capacity	11004/C	UKL-L	03/14		x	V	C	1000	75	6,60	294,68	x	
COOPER	3-5 doors, check towing capacity	11004/VM	UKL-L	03/14		x	V	VM	1000	75	6,60	390,08	x	
COUNTRYMAN	R60 ESTATE 3-5 doors, no Cooper S, no Cooper SD, no spare wheel, check towing capacity	11003/F	UKL-X	09/10	12/16	x	v	F	750	50	7,50	184,44	x	
COUNTRYMAN	R60 ESTATE 3-5 doors, no Cooper S, no Cooper SD, no spare wheel, check towing capacity	11003/C	UKL-X	09/10	12/16	x	v	C	750	50	7,50	307,40	x	















														
COUNTRYMAN	R60 ESTATE 3-5 doors, no Cooper S, no Cooper SD, no spare wheel, check towing capacity	11003/VM	UKL-X	09/10	12/16	x	v	VM	750	50	7,50	390,08	x	x
COUNTRYMAN	2-4 WD	06036/F	FMX	01/17		x		F	2086	80	10,70	169,60	x	x
COUNTRYMAN	2-4 WD	06036/C	FMX	01/17		x		C	2086	80	10,70	286,20	x	x
COUNTRYMAN	2-4 WD	06036/VM	FMX	01/17		x		VM	2086	80	10,70	355,10	x	x
ONE	R56 Saloon 3 doors, no Cooper S, no spare wheel, check towing capacity	11001/F	VKL-L , MINI N	11/06	02/14	x		F	750	50	6,00	184,44	x	x
ONE	R56 Saloon 3 doors, no Cooper S, no spare wheel, check towing capacity	11001/C	VKL-L , MINI N	11/06	02/14	x		C	750	50	6,00	294,68	x	x
ONE	R56 Saloon 3 doors, no Cooper S, no spare wheel, check towing capacity	11001/VM	VKL-L , MINI N	11/06	02/14	x		VM	750	50	6,00	390,08	x	x
ONE	3-5 doors, check towing capacity	11004/F	UKL-L	03/14		x	v	F	1000	75	6,60	184,44	x	x
ONE	3-5 doors, check towing capacity	11004/C	UKL-L	03/14		x	v	C	1000	75	6,60	294,68	x	x
ONE	3-5 doors, check towing capacity	11004/VM	UKL-L	03/14		x	v	VM	1000	75	6,60	390,08	x	x
mitsubishi														
ASX	SUV	24020/F	GAO	05/10		x	i	F	1400	70	8,60	196,10	x	x
ASX	SUV	24020/C	GAO	05/10		x		C	1400	70	8,60	275,60	x	x
ASX	SUV	24020/VM	GAO	05/10		x	i	VM	1400	70	8,60	361,46	x	x
COLT	HATCHBACK 5 doors, no 3 doors VERSION	24014	Z30	06/04		x	i	C	1000	50	6,70	275,60	x	x
ECLIPSE CROSS	SUV	24020/F	GAO	01/18		x		F	1400	70	8,60	196,10	x	x
ECLIPSE CROSS	SUV	24020/C	GAO	01/18		x		C	1400	70	8,60	275,60	x	x
ECLIPSE CROSS	SUV	24020/VM	GAO	01/18		x		VM	1400	70	8,60	361,46	x	x
L200	4WD, Single Cab, Club Cab, with step bumper, tubular bumper, total length between 5,00 and 5,12 m	24022/F	KAOT, KJOT, KTOT	03/06	07/15	x		F	3567	160	16,30	232,14	x	x
L200	4WD, Single Cab, Club Cab, with step bumper, tubular bumper, total length between 5,00 and 5,12 m	24022/C	KAOT, KJOT, KTOT	03/06	07/15	x		C	3567	160	16,30	324,36	x	x
L200	4WD, Single Cab, Club Cab, with step bumper, tubular bumper, total length between 5,00 and 5,12 m	24022/SF	KAOT, KJOT, KTOT	03/06	07/15	x		SF(C)	3567	160	16,30	265,00	x	x
L200	4WD, Single Cab, Club Cab, with step bumper, tubular bumper, total length between 5,00 and 5,12 m	24022/G	KAOT, KJOT, KTOT	03/06	07/15	x		GRIFO(C)	3567	160	16,30	339,20	x	x
L200	4WD, Single Cab, Club Cab, with step bumper, tubular bumper, total length between 5,00 and 5,12 m	24022/SFM	KAOT, KJOT, KTOT	03/06	07/15	x		SFM(C)	3567	160	16,30	434,60	x	x
L200	4WD My 2010 Double Cab, with step bumper, tubular bumper, total length >= m 5,185	24019/F	KAOT	03/10	07/15	x		F	2700	115	15,00	244,86	x	x
L200	4WD My 2010 Double Cab, with step bumper, tubular bumper, total length >= m 5,185	24019/C	KAOT	03/10	07/15	x		C	2700	115	15,00	301,04	x	x
L200	4WD My 2010 Double Cab, with step bumper, tubular bumper, total length >= m 5,185	24019/SF	KAOT	03/10	07/15	x		SF(C)	2700	115	15,00	295,74	x	x
L200	4WD My 2010 Double Cab, with step bumper, tubular bumper, total length >= m 5,185	24019/G	KAOT	03/10	07/15	x		GRIFO	2700	115	15,00	516,22	x	x
L200	4WD, Double Cab, with or without step bumper	24022/F	KAOT, KJOT, KTOT	03/06	02/10	x		F	3567	160	16,30	232,14	x	x















														
L200	4WD, Double Cab, with or without step bumper	24022/C	KA0T, KJ0T, KT0T	03/06	02/10	x		C	3567	160	16,30	324,36	x	
L200	4WD, Double Cab, with or without step bumper	24022/SF	KA0T, KJ0T, KT0T	03/06	02/10	x		SF(C)	3567	160	16,30	265,00	x	
L200	4WD, Double Cab, with or without step bumper	24022/G	KA0T, KJ0T, KT0T	03/06	02/10	x		GRIFO(C)	3567	160	16,30	339,20	x	
L200	4WD, Double Cab, with or without step bumper	24022/SFM	KA0T, KJ0T, KT0T	03/06	02/10	x		SFM(C)	3567	160	16,30	434,60	x	
L200	4WD, Double Cab, Club Cab with or without step bumper	24022/F	KA0T, KJ0T, KT0T	08/15	08/19	x		F	3567	160	16,30	232,14	x	
L200	4WD, Double Cab, Club Cab with or without step bumper	24022/C	KA0T, KJ0T, KT0T	08/15	08/19	x		C	3567	160	16,30	324,36	x	
L200	4WD, Double Cab, Club Cab with or without step bumper	24022/SF	KA0T, KJ0T, KT0T	08/15	08/19	x		SF(C)	3567	160	16,30	265,00	x	
L200	4WD, Double Cab, Club Cab with or without step bumper	24022/G	KA0T, KJ0T, KT0T	08/15	08/19	x		GRIFO(C)	3567	160	16,30	339,20	x	
L200	4WD, Double Cab, Club Cab with or without step bumper	24022/SFM	KA0T, KJ0T, KT0T	08/15	08/19	x		SFM(C)	3567	160	16,30	434,60	x	
L200	4WD, Single Cab, Double Cab, Club Cab, AdBlue, with or without step bumper	24022/F	KJ0T	09/19		x		F	3567	160	16,30	232,14		x
L200	4WD, Single Cab, Double Cab, Club Cab, AdBlue, with or without step bumper	24022/C	KJ0T	09/19		x		C	3567	160	16,30	324,36		x
L200	4WD, Single Cab, Double Cab, Club Cab, AdBlue, with or without step bumper	24022/SF	KJ0T	09/19		x		SF(C)	3567	160	16,30	265,00		x
L200	4WD, Single Cab, Double Cab, Club Cab, AdBlue, with or without step bumper	24022/G	KJ0T	09/19		x		GRIFO(C)	3567	160	16,30	339,20		x
L200	4WD, Single Cab, Double Cab, Club Cab, AdBlue, with or without step bumper	24022/SFM	KJ0T	09/19		x		SFM(C)	3567	160	16,30	434,60		x
L200	PICK-UP 4WD	24008	K	91	02/06			C	2700	100	14,50	275,60	x	
OUTLANDER	2-4WD	24013/F	CUOW	04/03	12/06			F	1500	75	10,50	227,90	x	
OUTLANDER	2-4WD	24013	CUOW	04/03	12/06			C	1500	75	10,50	332,84	x	
OUTLANDER	2-4WD, with platform	24018/F	CW0, CWB	07/07	09/12		i	F	2000	100	11,00	256,52		x
OUTLANDER	2-4WD, with platform	24018/C	CW0, CWB	07/07	09/12		i	C	2000	100	11,00	336,02		x
OUTLANDER	2-4WD	24021/F	C CW0, CWB	10/12		x	i	F	2000	100	11,20	196,10		x
OUTLANDER	2-4WD	24021/C	C CW0, CWB	10/12		x	i	C	2000	100	11,20	312,70		x
OUTLANDER	2-4WD	24021/VM	C CW0, CWB	10/12		x	i	VM	2000	100	11,20	392,20		x
OUTLANDER	2-4WD	24023/F	ZL	04/21				F	2286	115	11,00	220,00		x
OUTLANDER	2-4WD	24023/C	ZL	04/21				C	2286	115	11,00	315,00		x
PAJERO	4WD 2-4 doors	24015	L, V, V20, V24	85	01/00			C	3500	135	15,00	220,48	x	
PAJERO	4WD 2 doors	24017/2C	V, V60, V64, V80	05/00			i	C	3500	135	16,00	331,78	x	
PAJERO	4WD 2 doors	24017/2SF	V, V60, V64, V80	05/00			i	SF(C)	3500	135	16,00	307,40	x	
PAJERO	4WD 2 doors	24017/2G	V, V60, V64, V80	05/00			i	GRIFO(C)	3500	135	16,00	443,08	x	
PAJERO	4WD 4 doors	24017/4C	V, V60, V64, V80	05/00			i	C	3500	135	16,00	331,78	x	
PAJERO	4WD 4 doors	24017/4SF	V, V60, V64, V80	05/00			i	SF(C)	3500	135	16,00	307,40	x	
PAJERO	4WD 4 doors	24017/4G	V, V60, V64, V80	05/00			i	GRIFO(C)	3500	135	16,00	443,08	x	
PAJERO PININ	4WD 3 doors L=3.735	24012/C	H60W, H66W	00				C	1500	75	9,50	261,82	x	















															
PAJERO PININ	4WD 5 doors L=4.038	24012/L	H60W, H66W	00			i	C	1500	75	9,50	275,60	x		
PAJERO SPORT	4WD 4 doors	24007	K90, K94	01/99	08			C	2800	115	14,50	263,94	x		
SPACE STAR	MPV	24011	DGO	01/99	02/13	x	v	C	1400	75	8,00	275,60	x		
NISSAN															
ALMERA	HATCHBACK 3-5 doors	26015/F	N16	01/00		x	v	F	1200	75	7,80	209,88	x		
ALMERA	HATCHBACK 3-5 doors	26015	N16	01/00		x	v	C	1200	75	7,80	314,82	x		
ALMERA TINO	MPV	26016/F	V10	01/00	7	x	v	F	1250	75	8,40	209,88	x		
ALMERA TINO	MPV	26016	V10	01/00	07	x	v	C	1250	75	8,40	314,82	x		
CABSTAR		26013	TL	98	05			C	2800	120	15,80	398,56	x		
EVALIA	MPV	26027	M20	09		x	i	C	1100	75	7,50	294,68		x	
INTERSTAR	VAN	31101/SF	ED, FD, JD, ND, PD, E9, F3, F9	98	02/10			SF	2300	100	13,80	238,50	x		
INTERSTAR	VAN	31101/G	ED, FD, JD, ND, PD, E9, F3, F9	98	02/10			G	2300	100	13,80	443,08	x		
JUKE	2WD, no 4x4	26028/F	F15	10/10	07/19	x		F	1250	75	8,50	208,82		x	
JUKE	2WD, no 4x4	26028/C	F15	10/10	07/19	x		C	1250	75	8,50	311,64		x	
JUKE II	2WD	26035/F	F16	08/19		x	i	F	1373	85	7,50	220,00		x	
JUKE II	2WD	26035/C	F16	08/19		x	i	C	1373	85	7,50	295,00		x	
JUKE II	2WD	26035/VM	F16	08/19		x	i	VM	1373	85	7,50	370,00		x	
KING-CAB	no DOUBLE-CAB	26009	D21	01/94	07/05	x		C	2000	100		254,40	x		
KING-CAB	DOUBLE-CAB 4WD	26018	UD22	98	15	x		C	3000	120	14,70	288,32	x		
KUBISTAR	MPV, no 4X4, no GRANVOLUME	31096/F	FC, KC, F1	97	03			F	1355	75	8,60	178,08	x		
KUBISTAR	MPV, no 4X4, no GRANVOLUME	31096/C	FC, KC, F1	97	03			C	1355	75	8,60	284,08	x		
MICRA	HATCHBACK 3-5 doors	26008	K11	92	01/98	x	v	C	750	50		212,00	x		
MICRA	HATCHBACK 3-5 doors, no COUPE'	26019	K12	03/03	12/10	x	i	C	1025	50	6,70	263,94	x		
MICRA	HATCHBACK 5 doors	26033/F	K14	03/17		x	i	F	1294	75	7,00	227,90		x	
MICRA	HATCHBACK 5 doors	26033/C	K14	03/17		x	i	C	1294	75	7,00	309,52		x	
NAVARA	2-4WD 2-4 doors, bumper with platform	26022/PF	D40	08/05	12/15			F	3000	120	15,00	209,88	x		
NAVARA	2-4WD 2-4 doors, bumper with platform	26022/PSF	D40	08/05	12/15			SF(C)	3000	120	15,00	334,96	x		
NAVARA	2-4WD 2-4 doors, bumper with platform	26022/PC	D40	08/05	12/15			C	3000	120	15,00	295,74	x		
NAVARA	2-4WD 2-4 doors, bumper with platform	26022/PG	D40	08/05	12/15			GRIFO(C)	3000	120	15,00	510,92	x		
NAVARA	2-4WD 2-4 doors, tubular bumper	26022/TF	D40	08/05	12/15			F	3000	120	15,00	196,10	x		
NAVARA	2-4WD 2-4 doors, tubular bumper	26022/TC	D40	08/05	12/15			C	3000	120	15,00	295,74	x		
NAVARA	2-4WD 2-4 doors, tubular bumper	26022/TSF	D40	08/05	12/15			SF	3000	120	15,00	334,96	x		
NAVARA	2-4WD 2-4 doors, tubular bumper	26022/TG	D40	08/05	12/15			GRIFO	3000	120	15,00	510,92	x		
NAVARA	PICK-UP 2-4WD	26032/SF	D23	01/16				SF	3712	140	17,00	221,54		x	
NAVARA	PICK-UP 2-4WD	26032/G	D23	01/16				G	3712	140	17,00	326,48		x	
NAVARA	PICK-UP 2-4WD	26032/SFM	D23	01/16				SFM	3712	140	17,00	376,30		x	
NAVARA NP 300	PICK-UP 2-4WD	26032/SF	D23	01/16				SF	3712	140	17,00	221,54		x	
NAVARA NP 300	PICK-UP 2-4WD	26032/G	D23	01/16				G	3712	140	17,00	326,48		x	
NAVARA NP 300	PICK-UP 2-4WD	26032/SFM	D23	01/16				SFM	3712	140	17,00	376,30		x	
NOTE	HATCHBACK 5 doors, no E12	26023/F	E11	04/06	13	x	i	F	1000	50	6,70	184,44		x	
NOTE	HATCHBACK 5 doors, no E12	26023/C	E11	04/06	13	x	i	C	1000	50	6,70	270,30		x	
NOTE	HATCHBACK 5 doors, no E12	26023/VM	E11	04/06	13	x	i	VM	1000	50	6,70	355,10		x	
NP300	4WD	26018	D22	08		x		C	3000	120	14,70	288,32	x		
NV200	MPV	26027	M20	11/09		x	i	C	1100	75	7,50	294,68		x	















														
NV300	VAN	31103/SF	4	09/16				SF	2366	120	12,50	190,80	x	x
NV300	VAN	31103/G	4	09/16				GRIFO	2366	120	12,50	471,70	x	x
NV400	VAN front wheel drive only	31104/SF	MA, MR, M9A, MF, MW, M9, M1, MS, ML, VA, V1	03/12				SF	3076	120	15,00	258,64	x	x
NV400	VAN front wheel drive only	31104/G	MA, MR, M9A, MF, MW, M9, M1, MS, ML, VA, V1	03/12				GRIFO	3076	120	15,00	434,60	x	x
PATHFINDER	4WD	26021/C	R51	01/05			i	C	3000	120	15,00	248,04	x	x
PATHFINDER	4WD	26021/SF	R51	01/05			i	SF	3000	120	15,00	215,18	x	x
PATHFINDER	4WD	26021/G	R51	01/05			i	GM	3000	120	15,00	431,42	x	x
PATROL GR	4WD 2-4 doors	26012	Y61, Y60	89	09/04	x		C	3500	140	16,00	253,34	x	x
PRIMASTAR	VAN	31099/SF	FL, F4, F7, J4	09/02	14			SF	2000	80	12,50	190,80	x	x
PRIMASTAR	VAN	31075	FL, F4, F7, J4	09/02	14			C	2000	80	12,50	219,42	x	x
PRIMERA	Saloon, HATCHBACK	26011	P11	01/96	09/99	x	i	C	1400	75	8,40	275,60	x	x
PRIMERA	ESTATE	26020	P 12H, P 12F, P 12S	01/02		x	v	C	1850	75	9,50	327,54	x	x
QASHQAI	2-4WD, No AdBlue	26029/F	J10, J11	01/07	09/18	x	i	F	1800	75	9,80	208,82	x	x
QASHQAI	2-4WD, No AdBlue	26029/C	J10, J11	01/07	09/18	x	i	C	1800	75	9,80	338,14	x	x
QASHQAI	2-4WD, No AdBlue	26029/VM	J10, J11	01/07	09/18	x	i	VM	1800	75	9,80	392,20	x	x
QASHQAI	2-4WD, AdBlue	26034/F	J10, J11	10/18	05/21	x	v	F	2047	110	10,00	208,82	x	x
QASHQAI	2-4WD, AdBlue	26034/C	J10, J11	10/18	05/21	x	v	C	2047	110	10,00	338,14	x	x
QASHQAI	2-4WD, AdBlue	26034/VM	J10, J11	10/18	05/21	x	v	VM	2047	110	10,00	392,20	x	x
QASHQAI	2-4WD, HYBRID	26036/F	J12	06/21		x	i	F	2251	110	10,50	240,00	x	x
QASHQAI	2-4WD, HYBRID	26036/C	J12	06/21		x	i	C	2251	110	10,50	310,00	x	x
QASHQAI	2-4WD, HYBRID	26036/VM	J12	06/21		x	i	VM	2251	110	10,50	385,00	x	x
QASHQAI+2	2-4WD	26029/F	J10, J11	01/07	13	x	i	F	1800	75	9,80	208,82	x	x
QASHQAI+2	2-4WD	26029/C	J10, J11	01/07	13	x	i	C	1800	75	9,80	338,14	x	x
QASHQAI+2	2-4WD	26029/VM	J10, J11	01/07	13	x	i	VM	1800	75	9,80	392,20	x	x
TERRANO II	4WD 2-4 doors Restyling	26010	R20	02/93				C	3000	120	13,67	242,74	x	x
TOWNSTAR	MPV, VAN	31113/1F	NFK	01/22		x	i	F	1737	90	9,60	206,70	x	x
TOWNSTAR	MPV, VAN	31113/1C	NFK	01/22		x	i	C	1737	90	9,60	280,90	x	x
TOWNSTAR	MPV, VAN	31113/1VM	NFK	01/22		x	i	VM	1737	90	9,60	365,70	x	x
X-TRAIL	2-4WD	26017/F	T30	09/01	05/07	x	v	F	2000	100	11,00	297,86	x	x
X-TRAIL	2-4WD	26017	T30	09/01	05/07	x	v	C	2000	100	11,00	347,68	x	x
X-TRAIL	2-4WD, no parking sensors	26025/F	T31	06/07	07/14	x	v	F	2200	100	11,00	242,74	x	x
X-TRAIL	2-4WD, no parking sensors	26025/C	T31	06/07	07/14	x	v	C	2200	100	11,00	332,84	x	x
X-TRAIL	2-4WD	26030/F	T32, T31	07/14	08/22	x	i	F	2208	100	11,10	208,82	x	x
X-TRAIL	2-4WD	26030/C	T32, T31	07/14	08/22	x	i	C	2208	100	11,10	312,70	x	x
X-TRAIL	2-4WD	26030/VM	T32, T31	07/14	08/22	x	i	VM	2208	100	11,10	383,72	x	x
OPEL/VAUXHALL														
AGILA	MPV 4 seats	37012	H00	01/00	02		v	C	650	30	5,40	314,82	x	x
AGILA	MPV 5 seats	37016	H00	02	02/08			C	800	35	5,60	314,82	x	x
ANTARA	SUV 4WD	28056/F	L-A, ANTARA VAN	02/06				F	2000	80	12,50	215,18	x	x
ANTARA	SUV 4WD	28056/SF	L-A, ANTARA VAN	02/06				SF	2000	80	12,50	270,30	x	x















														
ANTARA	SUV 4WD	28056/C	L-A, ANTARA VAN	02/06				C	2000	80	12,50	312,70		x
ANTARA	SUV 4WD	28056/VM	L-A, ANTARA VAN	02/06				VM	2000	80	12,50	397,50		x
ANTARA	SUV 4WD	28056/G	L-A, ANTARA VAN	02/06				GM	2000	80	12,50	502,44		x
ASTRA	CABRIO, COUPÉ, check towing capacity	28044	T98	98	04	x	i	C	1300	75	8,00	238,50	x	
ASTRA	TWIN TOP CABRIO COUPE'	28057/F	A-H/C	07		x		F	1200	60	8,30	184,44		x
ASTRA	TWIN TOP CABRIO COUPE'	28057/C	A-H/C	07		x	i	C	1200	60	8,30	325,42		x
ASTRA	TWIN TOP CABRIO COUPE'	28057/VM	A-H/C	07		x	i	VM	1200	60	8,30	386,90		x
ASTRA F	ESTATE	28035	F, T92 KOMBI	91	98	x		C	1200	75		196,10	x	
ASTRA G	HATCHBACK 3-5 doors	28044	T98	11/98	11/03	x		C	1300	75	8,00	238,50		x
ASTRA G	ESTATE	28043/F	T98, KOMBI, ASTRA	04/98	07/04	x	i	F	1300	75	8,20	186,56	x	
ASTRA G	ESTATE	28043	T98, KOMBI, ASTRA	04/98	07/04	x	i	C	1300	75	8,20	248,04	x	
ASTRA H	HATCHBACK 5 doors, LPG	28053/F	A-H/C, A-H, GMIH	01/04	10			F	1500	75	8,50	184,44		x
ASTRA H	HATCHBACK 5 doors, LPG	28053/C	A-H/C, A-H, GMIH	01/04	10			C	1500	75	8,50	220,48		x
ASTRA H	ESTATE	28054/F	A - H/SW, H VAN, GMIJ, ASTRA-H	08/04	11/10	x		F	1400	75	8,80	184,44		x
ASTRA H	ESTATE	28054/C	A - H/SW, H VAN, GMIJ, ASTRA-H	08/04	11/10	x		C	1400	75	8,80	220,48		x
ASTRA H	ESTATE	28054/VM	A - H/SW, H VAN, GMIJ, ASTRA-H	08/04	11/10	x		VM	1400	75	8,80	326,48		x
ASTRA H GTC	HATCHBACK 3 doors	28053/F	A-H/C, A-H, GMIH	01/04	11/11			F	1500	75	8,50	184,44		x
ASTRA H GTC	HATCHBACK 3 doors	28053/C	A-H/C, A-H, GMIH	01/04	11/11			C	1500	75	8,50	220,48		x
ASTRA J	HATCHBACK 5 doors	28059/F	P-J	12/09	08/15	x	i	F	1500	75	9,00	184,44		x
ASTRA J	HATCHBACK 5 doors	28059/C	P-J	12/09	08/15	x	i	C	1500	75	9,00	270,30		x
ASTRA J	HATCHBACK 5 doors	28059/VM	P-J	12/09	08/15	x	i	VM	1500	75	9,00	318,00		x
ASTRA J GTC	HATCHBACK 3 doors	28062/F	P-J SW	12/11		x	i	F	1500	75	9,80	184,44		x
ASTRA J GTC	HATCHBACK 3 doors	28062/C	P-J SW	12/11		x	i	C	1500	75	9,80	294,68		x
ASTRA J GTC	HATCHBACK 3 doors	28062/VM	P-J SW	12/11		x	i	VM	1500	75	9,80	365,70		x
ASTRA J SPORTS TOURER	ESTATE	28061/F	P-J/SW	12/10	02/16	x	i	F	1500	75	9,80	184,44		x
ASTRA J SPORTS TOURER	ESTATE	28061/C	P-J/SW	12/10	02/16	x	i	C	1500	75	9,80	220,48		x
ASTRA J SPORTS TOURER	ESTATE	28061/VM	P-J/SW	12/10	02/16	x	i	VM	1500	75	9,80	318,00		x
ASTRA K	HATCHBACK 5 doors	28065/F	B-K	09/15	09/21	x	i	F	2372	75	10,50	192,92		x
ASTRA K	HATCHBACK 5 doors	28065/C	B-K	09/15	09/21	x	i	C	2372	75	10,50	286,20		x
ASTRA K	HATCHBACK 5 doors	28065/VM	B-K	09/15	09/21	x	i	VM	2372	75	10,50	349,80		x
ASTRA K SPORTS TOURER	ESTATE	28065/F	B-K	03/16	09/21	x		F	2372	75	10,50	192,92		x
ASTRA K SPORTS TOURER	ESTATE	28065/C	B-K	03/16	09/21	x	i	C	2372	75	10,50	286,20		x











														
ASTRA K SPORTS TOURER	ESTATE	28065/VM	B-K	03/16	09/21	x	i	VM	2372	75	10,50	349,80		x
ASTRA K SPORTS TOURER +	ESTATE	28065/F	B-K	03/16	09/21	x		F	2372	75	10,50	192,92		x
ASTRA K SPORTS TOURER +	ESTATE	28065/C	B-K	03/16	09/21	x	i	C	2372	75	10,50	286,20		x
ASTRA K SPORTS TOURER +	ESTATE	28065/VM	B-K	03/16	09/21	x	i	VM	2372	75	10,50	349,80		x
CAMPO	PICK-UP 4WD CHASSIS N. JAA...	17002	TFS	92				C	2000	120	11,70	267,12	x	
COMBO B	VAN	28037	COMBO B	94	01	x		C	1000	50	6,50	267,12	x	
COMBO D	VAN	13157/F	COMBO-D	12	07/18	x	i	F	1500	60	9,70	174,90		x
COMBO D	VAN	13157/C	COMBO-D	12	07/18	x	i	C	1500	60	9,70	256,52		x
COMBO D	VAN	13157/VM	COMBO-D	12	07/18	x	i	VM	1500	60	9,70	338,14		x
COMBO	SIZE M MPV L=4.400, to open the doors of the version with double rear opening the trailer needs to be detached	07052/F	E	08/18				F	1504	75	8,90	184,44		x
COMBO	SIZE M MPV L=4.400, to open the doors of the version with double rear opening the trailer needs to be detached	07052/C	E	08/18				C	1504	75	8,90	237,44		x
COMBO	SIZE M MPV L=4.400, to open the doors of the version with double rear opening the trailer needs to be detached	07052/VM	E	08/18				VM	1504	75	8,90	332,84		x
COMBO	SIZE XL MPV L=4.753	07053/F	E	08/18				F	1504	75	8,90	184,44		x
COMBO	SIZE XL MPV L=4.753	07053/C	E	08/18				C	1504	75	8,90	237,44		x
COMBO	SIZE XL MPV L=4.753	07053/VM	E	08/18				VM	1504	75	8,90	332,84		x
CORSA B	HATCHBACK 3-5 doors	28036	S 93	93	00	x	v	C	1000	50		213,06	x	
CORSA C	HATCHBACK 3-5 doors	28047/F	CORSA-C	00	08/06	x	i	F	1200	50	7,30	174,90		
CORSA C	HATCHBACK 3-5 doors	28047	CORSA-C	00	08/06	x	i	C	1200	50	7,30	267,12	x	
CORSA D	HATCHBACK 3-5 doors Restyling, LPG	13149/F	S-D	09/06	12/14	x	i	F	1300	75	7,50	171,72		x
CORSA D	HATCHBACK 3-5 doors Restyling, LPG	13149/C	S-D	09/06	12/14	x	i	C	1300	75	7,50	239,56		x
CORSA D	HATCHBACK 3-5 doors Restyling, LPG	13149/VM	S-D	09/06	12/14	x	i	VM	1300	75	7,50	338,14		x
CORSA E	HATCHBACK 3-5 doors Restyling, LPG	13149/F	S-D	01/15	08/19	x	i	F	1300	75	7,50	171,72		x
CORSA E	HATCHBACK 3-5 doors Restyling, LPG	13149/C	S-D	01/15	08/19	x	i	C	1300	75	7,50	239,56		x
CORSA E	HATCHBACK 3-5 doors Restyling, LPG	13149/VM	S-D	01/15	08/19	x	i	VM	1300	75	7,50	338,14		x
CORSA	HATCHBACK 3-5 doors	29053/F	U	9/19		x	i	F	1253	55	7,20	217,30		x
CORSA	HATCHBACK 3-5 doors	29053/C	U	12/19		x	i	C	1253	55	7,20	294,68		x
CORSA	HATCHBACK 3-5 doors	29053/VM	U	12/19		x	i	VM	1253	55	7,20	337,08		x
CROSSLAND X	SUV	28066/F	P7, 2 R	03/17		x	i	F	962	65	6,20	186,56		x
CROSSLAND X	SUV	28066/C	P7, 2 R	03/17		x	i	C	962	65	6,20	297,86		x
CROSSLAND X	SUV	28066/VM	P7, 2 R	03/17		x	i	VM	962	65	6,20	358,28		x
FRONTERA A	4WD 2-4 doors, check D value	28041	UT2, UT4	01/92	01/97			C	2000	75	11,80	251,22	x	
FRONTERA B	4WD 2-4 doors	28046	6A	04/99	12/04			C	2800	112	13,70	278,78	x	
GRANDLAND X	2-4WD, AdBlue, no hybrid, no model with parking sensors	29052/F	Z	03/17		x	v	F	2222	80	10,30	147,34		x
GRANDLAND X	2-4WD, AdBlue, no Hybrid	29052/C	Z	03/17		x	v	C	2222	80	10,30	267,12		x
GRANDLAND X	2-4WD, AdBlue, no Hybrid	29052/VM	Z	03/17		x	v	VM	2222	80	10,30	350,86		x
GRANDLAND X	HYBRID	28069/F	Z	01/20		x	v	F	1322	70	8,30	243,80		x
GRANDLAND X	HYBRID	28069/C	Z	01/20		x	v	C	1322	70	8,30	307,40		x
GRANDLAND X	HYBRID	28069/VM	Z	01/20		x	v	VM	1322	70	8,30	365,70		x
INSIGNIA	Saloon, no HATCHBACK	28058/F	OG-A	11/08	06/17	x	i	F	2000	85	11,30	220,48		x







														
INSIGNIA	Saloon, no HATCHBACK	28058/C	OG-A	11/08	06/17	x	i	C	2000	85	11,30	321,18	x	
INSIGNIA	Saloon, no HATCHBACK	28058/VM	OG-A	11/08	06/17	x	i	VM	2000	85	11,30	355,10	x	
INSIGNIA SPORTS TOURER	ESTATE	28058/F	OG-A	11/08	06/17	x	i	F	2000	85	11,30	220,48	x	
INSIGNIA SPORTS TOURER	ESTATE	28058/C	OG-A	11/08	06/17	x	i	C	2000	85	11,30	321,18	x	
INSIGNIA SPORTS TOURER	ESTATE, no 4x4	28058/VM	OG-A	11/08	06/17	x	i	VM	2000	85	11,30	355,10	x	
MERIVA	MPV	28050	X01 MONOCAB, Z1, GMIC	03/03	03/10	x	i	C	1200	50	8,00	301,04	x	
MERIVA	MPV	28050/F	X01 MONOCAB, Z1, GMIC	03/03	03/10	x	i	F	1200	50	8,00	174,90	x	
MERIVA B	MPV	28060/F	SD-MONOCAB, S-D	04/10		x		F	1300	75	8,00	190,80	x	
MERIVA B	MPV	28060/C	SD-MONOCAB, S-D	04/10		x		C	1300	75	8,00	294,68	x	
MERIVA B	MPV	28060/VM	SD-MONOCAB, S-D	04/10		x		VM	1300	75	8,00	355,10	x	
MOKKA	SUV 2-4WD	28064/F	J-A	11/12	08/20	x	v	F	1694	90	8,75	179,14	x	
MOKKA	SUV 2-4WD	28064/C	J-A	11/12	08/20	x	v	C	1694	90	8,75	284,08	x	
MOKKA	SUV 2-4WD	28064/VM	J-A	11/12	08/20	x	v	VM	1694	90	8,75	349,80	x	
MOKKA	SUV 2-4WD	29053/F	U S	09/20		x		F	1253	55	7,20	217,30	x	
MOKKA	SUV 2-4WD	29053/C	U S	09/20		x		C	1253	55	7,20	294,68	x	
MOKKA	SUV 2-4WD	29053/VM	U S	09/20		x		VM	1253	55	7,20	337,08	x	
MOKKA X	SUV 2-4WD	28064/F	J-A	11/12	08/20	x	v	F	1694	90	8,75	179,14	x	
MOKKA X	SUV 2-4WD	28064/C	J-A	11/12	08/20	x	v	C	1694	90	8,75	284,08	x	
MOKKA X	SUV 2-4WD	28064/VM	J-A	11/12	08/20	x	v	VM	1694	90	8,75	349,80	x	
MONTEREY		17003	UBB	92				C	3300	135	15,00	295,74	x	
MOVANO A	VAN	31101/SF	ED, FD, JD, ND, PD, E9, F3, F9	01/98	10/12			SF	2300	100	13,80	238,50	x	
MOVANO A	VAN	31101/G	ED, FD, JD, ND, PD, E9, F3, F9	01/98	10/12			G	2300	100	13,80	443,08	x	
MOVANO B	VAN front wheel drive only	31104/SF	MA, MR, M9A, MF, MW, M9, M1, MS, ML, VA, V1	03/10	12/21			SF	3076	120	15,00	258,64	x	
MOVANO B	VAN front wheel drive only	31104/G	MA, MR, M9A, MF, MW, M9, M1, MS, ML, VA, V1	03/10	12/21			GRIFO	3076	120	15,00	434,60	x	
MOVANO C	VAN,	13146	Y	12/21		x		C	3000	120	16,90	259,70	x	
OMEGA B	Saloon	28038	OMEGA B, V94	01/94		x		C	1900	75	11,00	235,32	x	
OMEGA B CARAVAN	ESTATE	28039	V94, KOMBI	01/94	04/03		i	C	1750	75	11,00	261,82	x	
SIGNUM	HATCHBACK 5 doors	28051/F	VECTRA/CAR, Z-C/S	03/03	09			F	1700	78	10,00	220,48	x	
SIGNUM	HATCHBACK 5 doors	28051/C	VECTRA/CAR, Z-C/S	03/03	09			C	1700	78	10,00	331,78	x	
SIGNUM	HATCHBACK 5 doors	28051/VM	VECTRA/CAR, Z-C/S	03/03	09			VM	1700	78	10,00	392,20	x	
VECTRA B	Saloon, HATCHBACK	28040/1	J96	01/96	01/99	x		C	1500	75	8,80	258,64	x	
VECTRA B	Saloon, HATCHBACK, Restyling	28040/2	J96	01/98	12/01	x	v	C	1700	75	8,80	258,64	x	
VECTRA B	ESTATE	28042	J96, KOMBI	95	12/01			C	1500	75	8,80	263,94	x	















														
VECTRA C	Saloon, HATCHBACK 5 doors	28049/F	VECTRA/LIM, VECTRA/CAR, Z-C	01/02		x	v	F	1600	78	9,50	184,44		x
VECTRA C	Saloon, HATCHBACK 5 doors	28049/C	VECTRA/LIM, VECTRA/CAR, Z-C	01/02		x	v	C	1600	78	9,50	277,72		x
VECTRA C	ESTATE	28052/F	VECTRA/SW, Z-C/SW	01/02				F	1800	78	10,60	233,20		x
VECTRA C	ESTATE	28052/C	VECTRA/SW, Z-C/SW	01/02				C	1800	78	10,60	303,16		x
VECTRA C	ESTATE	28052/VM	VECTRA/SW, Z-C/SW	01/02				VM	1800	78	10,60	339,20		x
VIVARO	VAN	31099/SF	F7, J7, U7, X83	01/01	09/14			SF	2000	80	12,50	190,80	x	
VIVARO	VAN	31075	F7, J7, U7, X83	01/01	09/14			C	2000	80	12,50	219,42	x	
VIVARO	VAN	31103/SF	L, X83, F7, JL	10/14	02/19			SF	2366	120	12,50	190,80		x
VIVARO	VAN	31103/G	L, X83, F7, JL	10/14	02/19			GRIFO	2366	120	12,50	471,70		x
VIVARO C	VAN	07049/F	V	03/19		x		F	2644	120	14,00	181,26		x
VIVARO C	VAN	07049/C	V	03/19		x		C	2644	120	14,00	254,40		x
ZAFIRA A	MPV	28048/F	T98 MONOCAB, A VAN	01/99	06/05	x	i	F	1500	75	8,70	192,92	x	
ZAFIRA A	MPV	28048/C	T98 MONOCAB, A VAN	01/99	06/05	x	i	C	1500	75	8,70	239,56	x	
ZAFIRA B	MPV, methane	28055/F	A-H/MONOCAB, ZAFIRA VAN	07/05	11/11	x	i	F	1500	75	9,60	184,44		x
ZAFIRA B	MPV, methane	28055/C	A-H/MONOCAB, ZAFIRA VAN	07/05	11/11	x	i	C	1500	75	9,60	272,42		x
ZAFIRA B	MPV, methane	28055/VM	A-H/MONOCAB, ZAFIRA VAN	07/05	11/11	x	i	VM	1500	75	9,60	364,64		x
ZAFIRA TOURER	MPV, ESTATE, methane	07106/1F	P-J/SW	11		x		F	1500	75	10,00	184,44		x
ZAFIRA TOURER	MPV, ESTATE, methane	07106/1C	P-J/SW	11		x		C	1500	75	10,00	283,02		x
ZAFIRA TOURER	MPV, ESTATE, methane	07106/VM	P-J/SW	11		x	i	VM	1500	75	10,00	339,20		x
ZAFIRA LIFE	VAN	07049/F	V	03/19		x		F	2644	120	14,00	181,26		x
ZAFIRA LIFE	VAN	07049/C	V	03/19		x		C	2644	120	14,00	254,40		x
PEUGEOT														
1007	MPV	29040/F	KM, JM, JG	07/05	01/09	x		F	1137	70	7,00	196,10		x
1007	MPV	29040/C	KM, JM, JG	07/05	01/09	x		C	1137	70	7,00	267,12		x
1007	MPV	29040/VM	KM, JM, JG	07/05	01/09	x		VM	1137	70	7,00	360,40		x
106	HATCHBACK	29026		01/91	05/96	x	v	C	800	56		236,38	x	
106	HATCHBACK 3-5 doors	07029	1A, 1C, 1S	05/96	05/05		i	C	700	50	4,83	200,34	x	
2008	SUV, no GT Line	29049/F	C	13	12/19	x	i	F	1300	60	8,10	208,82		x
2008	SUV, no GT Line	29049/C	C	13	12/19	x	i	C	1300	60	8,10	307,40		x
2008	SUV, no GT Line	29049/VM	C	13	12/19	x	i	VM	1300	60	8,10	361,46		x
2008	SUV, GT Line, no Full Electric	29053/F	U	01/20		x	i	F	1253	55	7,20	217,30		x
2008	SUV, GT Line, no Full Electric	29053/C	U	01/20		x	i	C	1253	55	7,20	294,68		x
2008	SUV, GT Line, no Full Electric	29053/VM	U	01/20		x	i	VM	1253	55	7,20	337,08		x
206	HATCHBACK 3-5 doors	29034/F	2A, 2C, 2G, 2H, 2S, 2I, 2D, 2M	01/98		x	v	F	1100	50	6,90	181,26		x
206	HATCHBACK 3-5 doors	29034	2A, 2C, 2G, 2H, 2S, 2I, 2D, 2M	01/98		x	v	C	1100	50	6,90	223,66		x
206	BREAK	29037	2E, 2K	02				C	1100	50	7,00	223,66	x	















													
206 CC	COUPÈ-CABRIO	29034/F	2A, 2C, 2G, 2H, 2S, 2I, 2D, 2M	02/01		x	v	F	1100	50	6,90	181,26	x
206 CC	COUPÈ-CABRIO	29034	2A, 2C, 2G, 2H, 2S, 2I, 2D, 2M	02/01		x	v	C	1100	50	6,90	223,66	x
207	HATCHBACK 3-5 doors	07050/F	WA,WC,WG,WM	01/06		x	i	F	1450	80	7,70	184,44	x
207	HATCHBACK 3-5 doors	07050/C	WA,WC,WG,WM	01/06		x	i	C	1450	80	7,70	268,18	x
207	HATCHBACK 3-5 doors	07050/VM	WA,WC,WG,WM	01/06		x	i	VM	1450	80	7,70	338,14	x
207	ESTATE	29042/F	WE, WU	01/06				F	1150	46	7,40	220,48	x
207	ESTATE	29042/C	WE, WU	01/06				C	1150	46	7,40	305,28	x
207	ESTATE	29042/VM	WE, WU	01/06				VM	1150	46	7,40	333,90	x
208	HATCHBACK 3-5 doors	07050/F	C	04/12	11/19	x		F	1450	80	7,70	184,44	x
208	HATCHBACK 3-5 doors	07050/C	C	04/12	11/19	x		C	1450	80	7,70	268,18	x
208	HATCHBACK 3-5 doors	07050/VM	C	04/12	11/19	x		VM	1450	80	7,70	338,14	x
208	HATCHBACK 3-5 doors, GT Line, no Full Electric	29053/F	U	12/19		x	i	F	1253	55	7,20	217,30	x
208	HATCHBACK 3-5 doors, GT Line, no Full Electric	29053/C	U	12/19		x	i	C	1253	55	7,20	294,68	x
208	HATCHBACK 3-5 doors, GT Line, no Full Electric	29053/VM	U	12/19		x	i	VM	1253	55	7,20	337,08	x
3008	MPV	29046/F	O	04/09	10/16	x		F	1500	75	9,00	147,34	x
3008	MPV	29046/C	O	04/09	10/16	x		C	1500	75	9,00	267,12	x
3008	MPV	29046/VM	O	04/09	10/16	x		VM	1500	75	9,00	350,86	x
3008	2-4WD, AdBlue,, no Hybrid, no model with parking sensors	29052/F	M J, M C, M 4, M3	11/16		x	v	F	2222	80	10,30	147,34	x
3008	2-4WD, AdBlue, no Hybrid	29052/C	M J, M C, M 4, M3	11/16		x	v	C	2222	80	10,30	267,12	x
3008	2-4WD, AdBlue, no Hybrid	29052/VM	M J, M C, M 4, M3	11/16		x	v	VM	2222	80	10,30	350,86	x
3008	HYBRID	28069/F	M	01/20		x	v	F	1322	70	8,30	243,80	x
3008	HYBRID	28069/C	M	01/20		x	v	C	1322	70	8,30	307,40	x
3008	HYBRID	28069/VM	M	01/20		x	v	VM	1322	70	8,30	365,70	x
306	HATCHBACK 3-5 doors, no CABRIO	29048/F	7A, 7C, 7S	01/93		x	i	F	1200	75		208,82	x
306	HATCHBACK 3-5 doors, no CABRIO	29048/C	7A, 7C, 7S	01/93		x	i	C	1200	75		319,06	x
306	ESTATE	29031	7E	06/97				C	1000	52	7,00	285,14	x
307	HATCHBACK 3-5 doors, no CABRIO	29043/F	3A, 3C, 3G	01/01		x	i	F	1340	76	9,30	184,44	x
307	HATCHBACK 3-5 doors, no CABRIO	29043/C	3A, 3C, 3G	01/01		x	i	C	1340	76	9,30	275,60	x
307	HATCHBACK 3-5 doors, no CABRIO	29043/VM	3A, 3C, 3G	01/01		x	i	VM	1340	76	9,30	365,70	x
307	ESTATE, MPV, no XSI	29036/F	3E, 3H	01/02		x	i	F	1500	72	9,00	198,22	x
307	ESTATE, MPV, no XSI	29036/C	3E, 3H	01/02		x	i	C	1500	72	9,00	301,04	x
308	HATCHBACK 3-5 doors, no CABRIO	29043/F	4A, 4C, 4G	07/07	13	x	i	F	1700	76	9,30	184,44	x
308	HATCHBACK 3-5 doors, no CABRIO	29043/C	4A, 4C, 4G	07/07	13	x	i	C	1700	76	9,30	275,60	x
308	HATCHBACK 3-5 doors, no CABRIO	29043/VM	4A, 4C, 4G	07/07	13	x	i	VM	1700	76	9,30	365,70	x
308	HATCHBACK 3-5 doors, no CABRIO	29050/F	L, FLN	13	05/21	x	i	F	1700	75	10,35	184,44	x
308	HATCHBACK 3-5 doors, no CABRIO	29050/C	L, FLN	13	05/21	x	i	C	1700	75	10,35	275,60	x
308	HATCHBACK 3-5 doors, no CABRIO	29050/VM	L, FLN	13	05/21	x	i	VM	1700	75	10,35	365,70	x
308	ESTATE	29044/F	4E, 4H	07/07	13			F	1700	70	9,70	190,80	x
308	ESTATE	29044/C	4E, 4H	07/07	13			C	1700	70	9,70	275,60	x
308	ESTATE	29044/VM	4E, 4H	07/07	13			VM	1700	70	9,70	365,70	x
308	ESTATE, no GT-LINE	07047/F	L	05/14	07/21		i	F	1797	70	9,80	202,46	x

















													
308	ESTATE, no GT-LINE	07047/C	L	05/14	07/21		i	C	1797	70	9,80	296,80	x
308	ESTATE, no GT-LINE	07047/VM	L	05/14	07/21		i	VM	1797	70	9,80	371,00	x
4007	SUV	24018/F	V	07/07	12		i	F	2000	100	11,00	256,52	x
4007	SUV	24018/C	V	07/07	12		i	C	2000	100	11,00	336,02	x
4008	SUV	24020/F		05/12		x	i	F	1400	70	8,60	196,10	x
4008	SUV	24020/C		05/12		x	i	C	1400	70	8,60	275,60	x
4008	SUV	24020/VM		05/12		x	i	VM	1400	70	8,60	361,46	x
406	Saloon, Restyling	29028	8B	95	01/99			C	1500	80	9,40	240,62	x
407	Saloon, no COUPÉ, ESTATE	07042/CF	6D, 6E	05/04	12/10	x		F	1800	75	10,80	233,20	x
407	Saloon, no COUPÉ, ESTATE	07042/CC	6D, 6E	05/04	12/10	x		C	1800	75	10,80	301,04	x
407	Saloon, no COUPÉ, ESTATE	07042/CVM	6D, 6E	05/04	12/10	x		VM	1800	75	10,80	355,10	x
5008	MPV 5-7seats	07041/F	O	11/10	12/16	x	v	F	1600	70	9,50	226,84	x
5008	MPV 5-7seats	07041/C	O	11/10	12/16	x	v	C	1600	70	9,50	298,92	x
5008	MPV 5-7seats	07041/VM	O	11/10	12/16	x	v	VM	1600	70	9,50	355,10	x
5008	2-4WD, AdBlue, no Hybrid, no model with parking sensors	29054/F	M J, M C, M 4	01/17		x	i	F	2222	80	10,30	147,34	x
5008	2-4WD, AdBlue, no Hybrid	29054/C	M J, M C, M 4	01/17		x	i	C	2222	80	10,30	267,12	x
5008	2-4WD, AdBlue, no Hybrid	29054/VM	M J, M C, M 4	01/17		x	i	VM	2222	80	10,30	350,86	x
508	Saloon	29051/C	8	03/11	10/18	x	i	C	2266	75	10,60	319,06	x
508	Saloon	29051/VM	8	03/11	10/18	x	i	VM	2266	75	10,60	361,46	x
508	ESTATE, no double exhaust pipe	29047/F	8	01/11	12/18	x	i	F	1875	75	10,80	196,10	x
508	ESTATE, no double exhaust pipe	29047/C	8	01/11	12/18	x	i	C	1875	75	10,80	294,68	x
508	ESTATE, no double exhaust pipe	29047/VM	8	01/11	12/18	x	i	VM	1875	75	10,80	390,08	x
806	MPV	13133/F	22, AB	01/94	03/02		v	F	1300	60	10,50	209,88	x
806	MPV	13133	22, AB	01/94	03/02		v	C	1300	60	10,50	268,18	x
807	MPV	13137/F	EA, EB	03/02			i	F	1850	76	11,00	209,88	x
807	MPV	13137/C	EA, EB	03/02			i	C	1850	76	11,00	295,74	x
BIPPER	VAN no Natural Power	13152/F	AA, AB, AJ	02/08				F	1000	60	6,50	181,26	x
BIPPER	VAN no Natural Power	13152	AA, AB, AJ	02/08				C	1000	60	6,50	235,32	x
BIPPER TEPEE	MPV no Natural Power	13152/F	AA, AB, AJ	02/08				F	1000	60	6,50	181,26	x
BIPPER TEPEE	MPV no Natural Power	13152	AA, AB, AJ	02/08				C	1000	60	6,50	235,32	x
BOXER	PICK UP, check D value	13147/C	Y	09/06				C	3000	120	16,90	358,28	x
BOXER	PICK UP, check D value	13147/G	Y	09/06				GRIFO	3000	120	16,90	552,26	x
BOXER	VAN, PICK UP, model with parking sensors, 4x4	13148/1SF	23, Z	94	05/06			SF	2000	110	13,40	258,64	x
BOXER	VAN, PICK UP, model with parking sensors, 4x4	13148/1G	23, Z	94	05/06			GRIFO	2000	110	13,40	521,52	x
BOXER	VAN, PICK UP model with parking sensors, no 4X4	13148/SF	23, Z	94	05/06			SF	2000	110	13,40	244,86	x
BOXER	VAN, PICK UP, model with parking sensors, no 4X4	13148/G	23, Z	94	05/06			GRIFO	2000	110	13,40	509,86	x
BOXER	VAN, check D value	13146	Y	06/06		x		C	3000	120	16,90	259,70	x
EXPERT	VAN	13133/F	22, A, B	94	07		v	F	1300	60	10,50	209,88	x
EXPERT	VAN	13133	22, A, B	94	07		v	C	1300	60	10,50	268,18	x
EXPERT	VAN	13151/F	X	01/07	16	x	i	F	2000	80	12,50	174,90	x
EXPERT	VAN	13151/C	X	01/07	16	x	i	C	2000	80	12,50	324,36	x
EXPERT	VAN	07049/F	V	04/16		x		F	2644	120	14,00	181,26	x
EXPERT	VAN	07049/C	V	04/16		x		C	2644	120	14,00	254,40	x















													
EXPERT TEPEE	MPV	13151/F	X	04/08	16	x	i	F	2000	80	12,50	174,90	x
EXPERT TEPEE	MPV	13151/C	X	04/08	16	x	i	C	2000	80	12,50	324,36	x
PARTNER	MPV, no CHASSIS VERSION	07045/F	5, G, M	01/96	03/08		i	F	1100	70	7,50	178,08	x
PARTNER	MPV, no CHASSIS VERSION	07045/C	5, G, M	01/96	03/08		i	C	1100	70	7,50	299,98	x
PARTNER	MPV L=4.380, to open the doors of the version with double rear opening the trailer needs to be detached	07052/F	7	04/08	07/18			F	1504	75	8,90	184,44	x
PARTNER	MPV L=4.380, to open the doors of the version with double rear opening the trailer needs to be detached	07052/C	7	04/08	07/18			C	1504	75	8,90	237,44	x
PARTNER	MPV L=4.380, to open the doors of the version with double rear opening the trailer needs to be detached	07052/VM	7	04/08	07/18			VM	1504	75	8,90	332,84	x
PARTNER	SIZE M MPV L=4.400, to open the doors of the version with double rear opening the trailer needs to be detached	07052/F	E	08/18				F	1504	75	8,90	184,44	x
PARTNER	SIZE M MPV L=4.400, to open the doors of the version with double rear opening the trailer needs to be detached	07052/C	E	08/18				C	1504	75	8,90	237,44	x
PARTNER	SIZE M MPV L=4.400, to open the doors of the version with double rear opening the trailer needs to be detached	07052/VM	E	08/18				VM	1504	75	8,90	332,84	x
PARTNER	L2 MPV L=4.628	07053/F	7	04/08	07/18			F	1504	75	8,90	184,44	x
PARTNER	L2 MPV L=4.628	07053/C	7	04/08	07/18			C	1504	75	8,90	237,44	x
PARTNER	L2 MPV L=4.628	07053/VM	7	04/08	07/18			VM	1504	75	8,90	332,84	x
PARTNER	SIZE M MPV L=4.753, to open the doors of the version with double rear opening the trailer needs to be detached	07053/F	E	08/18				F	1504	75	8,90	184,44	x
PARTNER	SIZE XL MPV L=4.753, to open the doors of the version with double rear opening the trailer needs to be detached	07053/C	E	08/18				C	1504	75	8,90	237,44	x
PARTNER	SIZE XL MPV L=4.753, to open the doors of the version with double rear opening the trailer needs to be detached	07053/VM	E	08/18				VM	1504	75	8,90	332,84	x
PARTNER TEPEE	MPV L=4.380	07052/F	7	04/08	07/18			F	1504	75	8,90	184,44	x
PARTNER TEPEE	MPV L=4.380	07052/C	7	04/08	07/18			C	1504	75	8,90	237,44	x
PARTNER TEPEE	MPV L=4.380	07052/VM	7	04/08	07/18			VM	1504	75	8,90	332,84	x
PARTNER TEPEE	SIZE M MPV L=4.753	07053/F	E	08/18				F	1504	75	8,90	184,44	x
PARTNER TEPEE	SIZE XL MPV L=4.753	07053/C	E	08/18				C	1504	75	8,90	237,44	x
PARTNER TEPEE	SIZE XL MPV L=4.753	07053/VM	E	08/18				VM	1504	75	8,90	332,84	x
PARTNER TEPEE	L2 MPV L=4.628	07053/F	7	04/08	07/18			F	1504	75	8,90	184,44	x
PARTNER TEPEE	L2 MPV L=4.628	07053/C	7	04/08	07/18			C	1504	75	8,90	237,44	x
PARTNER TEPEE	L2 MPV L=4.628	07053/VM	7	04/08	07/18			VM	1504	75	8,90	332,84	x
PARTNER TEPEE	SIZE M MPV L=4.400	07052/F	7	08/18				F	1504	75	8,90	184,44	x
PARTNER TEPEE	SIZE M MPV L=4.400	07052/C	7	08/18				C	1504	75	8,90	237,44	x
PARTNER TEPEE	SIZE M MPV L=4.400	07052/VM	7	08/18				VM	1504	75	8,90	332,84	x
RIFTER	SIZE M MPV L=4.400, to open the doors of the version with double rear opening the trailer needs to be detached	07052/F	E, FEHN	08/18				F	1504	75	8,90	184,44	x















															
RIFTER	SIZE M MPV L=4.400, to open the doors of the version with double rear opening the trailer needs to be detached	07052/C	E, FEHN	08/18					C	1504	75	8,90	237,44	x	
RIFTER	SIZE M MPV L=4.400, to open the doors of the version with double rear opening the trailer needs to be detached	07052/VM	E, FEHN	08/18					VM	1504	75	8,90	332,84	x	
RIFTER	SIZE M MPV L=4.753	07053/F	E	07/18					F	1504	75	8,90	184,44	x	
RIFTER	SIZE XL MPV L=4.753	07053/VM	E	07/18					VM	1504	75	8,90	332,84	x	
RIFTER	SIZE XL MPV L=4.753	07053/C	E	07/18					C	1504	75	8,90	237,44	x	
RANCH	VAN, no CHASSIS VERSION	07045/F	5, G, M	01/96	03/08			i	F	1100	70	7,50	178,08	x	
RANCH	MPV, no CHASSIS VERSION	07045/C	5, G, M	01/96	03/08			i	C	1100	70	7,50	299,98	x	
TRAVELLER	MPV	07049/F	V	04/16				x	F	2644	120	14,00	181,26	x	
TRAVELLER	MPV	07049/C	V	04/16				x	C	2644	120	14,00	254,40	x	
PORSCHE															
MACAN	SUV 2-4WD, check D value, it may be necessary to adapt the vehicle's cooling system	02029/F	95B	02/14				x	i	F	2000	80	11,30	208,82	x
MACAN	SUV 2-4WD, check D value, it may be necessary to adapt the vehicle's cooling system	02029/C	95B	02/14				x	i	C	2000	80	11,30	309,52	x
MACAN	SUV 2-4WD, check D value, it may be necessary to adapt the vehicle's cooling system	02029/VM	95B	02/14				x	i	VM	2000	80	11,30	398,56	x
RENAULT															
ALASKAN	PICK-UP 2-4WD	26032/SF	D23	01/17					SF	3712	140	17,00	221,54	x	
ALASKAN	PICK-UP 2-4WD	26032/G	D23	01/17					G	3712	140	17,00	326,48	x	
ALASKAN	PICK-UP 2-4WD	26032/SFM	D23	01/17					SFM	3712	140	17,00	376,30	x	
CAPTUR	CROSSOVER, no model with parking sensors	31100/F	R 2, R	05/13	12/19			x	V	F	1200	75	7,60	178,08	x
CAPTUR	CROSSOVER	31100/C	R 2, R	05/13	12/19			x	V	C	1200	75	7,60	256,52	x
CAPTUR	CROSSOVER	31100/VM	R 2, R	05/13	12/19			x	V	VM	1200	75	7,60	332,84	x
CAPTUR II	CROSSOVER, AdBlue	31112/F	RJB	01/20				x	i	F	1303	75	7,60	204,58	x
CAPTUR II	CROSSOVER, AdBlue	31112/C	RJB	01/20				x	i	C	1303	75	7,60	262,88	x
CAPTUR II	CROSSOVER, AdBlue	31112/VM	RJB	01/20				x	i	VM	1303	75	7,60	337,08	x
CAPTUR II	HYBRID	31114/F	RJB	01/20				x	i	F	1303	75	7,60	233,20	x
CAPTUR II	HYBRID	31114/C	RJB	01/20				x	i	C	1303	75	7,60	328,60	x
CAPTUR II	HYBRID	31114/VM	RJB	01/20				x	i	VM	1303	75	7,60	376,30	x
CLIO II	HATCHBACK 3-5 doors, CAMPUS	31068/F	BB, CB, SB	03/98	05				F	1200	75	7,50	184,44	x	
CLIO II	HATCHBACK 3-5 doors, CAMPUS	31068	BB, CB, SB	03/98	05				C	1200	75	7,50	243,80	x	
CLIO III	HATCHBACK 3-5 doors, no LPG	31083/F	BR, CR, SR	09/05	10/12				F	1200	75	7,50	178,08	x	
CLIO III	HATCHBACK 3-5 doors, no LPG	31083/C	BR, CR, SR	09/05	10/12				C	1200	75	7,50	267,12	x	
CLIO IV	HATCHBACK 3-5 doors, VAN, no GT LINE	31097/F	R 5, R 6, R-A, R	12/12	09/19				i	F	1200	80	7,50	201,40	x
CLIO IV	HATCHBACK 3-5 doors, VAN, no GT LINE	31097/C	R 5, R 6, R-A, R	12/12	09/19				i	C	1200	80	7,50	295,74	x
CLIO IV	HATCHBACK 3-5 doors, VAN, no GT LINE	31097/VM	R 5, R 6, R-A, R	12/12	09/19				i	VM	1200	80	7,50	386,90	x
CLIO V	HATCHBACK 3-5 doors, VAN, AdBlue, no Hybrid	31112/F	RJA	10/19				x	i	F	1303	75	7,60	204,58	x















													
CLIO V	HATCHBACK 3-5 doors, VAN, AdBlue, no Hybrid	31112/C	RJA	10/19		x	i	C	1303	75	7,60	262,88	x
CLIO V	HATCHBACK 3-5 doors, VAN, AdBlue, no Hybrid	31112/VM	RJA	10/19		x	i	VM	1303	75	7,60	337,08	x
CLIO SPORTER IV	ESTATE no GT LINE	31100/F	R 7	05/13		x	V	F	1200	75	7,60	178,08	x
CLIO SPORTER IV	ESTATE no GT LINE	31100/C	R 7	05/13		x	V	C	1200	75	7,60	256,52	x
CLIO SPORTER IV	ESTATE no GT LINE	31100/VM	R 7	05/13		x	V	VM	1200	75	7,60	332,84	x
CLIO SPORTOUR	ESTATE	31086/F	KR	02/08	04/13			F	1200	75	7,40	196,10	x
CLIO SPORTOUR	ESTATE	31086/C	KR	02/08	04/13			C	1200	75	7,40	273,48	x
ESPACE III	MPV	31067	JE	01/97	12/01			C	2000	85	11,50	236,38	x
ESPACE IV	MPV	31077/F	JK??A?, JK??B?	01/02	05/15		i	F	2000	80	11,70	256,52	x
ESPACE IV	MPV	31077	JK??A?, JK??B?	01/02	05/15		i	C	2000	80	11,70	328,60	x
ESPACE V	MPV	31109/F	RFC	06/15		x		F	2087	80	11,10	204,58	
ESPACE V	MPV	31109/C	RFC	06/15		x		C	2087	80	11,10	312,70	
ESPACE V	MPV	31109/VM	RFC	06/15		x		VM	2087	80	11,10	373,12	
EXPRESS	VAN	08005/F	RJK	05/21				F	1200	75	7,50	184,44	x
EXPRESS	VAN	08005/C	RJK	05/21				C	1200	75	7,50	294,68	x
GRAND ESPACE	MPV	31067	JE	97	02			C	2000	85	11,50	236,38	x
GRAND ESPACE	MPV	31081/F	JK??C, JK??D	02	05/15			F	2000	80	11,70	220,48	x
GRAND ESPACE	MPV	31081/C	JK??C, JK??D	02	05/15			C	2000	80	11,70	342,38	x
GRAND ESPACE	MPV	31081/VM	JK??C, JK??D	02	05/15			VM	2000	80	11,70	392,20	x
GRAND SCENIC II	MPV 7seats	31105/F	JM	01/04	01/09	x		F	1480	75	8,80	220,48	x
GRAND SCENIC II	MPV 7seats	31105/C	JM	01/04	01/09	x	i	C	1480	75	8,80	279,84	x
GRAND SCENIC II	MPV 7seats	31105/VM	JM	01/04	01/09	x	i	VM	1480	75	8,80	349,80	x
GRAND SCENIC III	MPV 7seats	31105/F	JZ	02/09	08/16	x	i	F	1480	75	8,80	220,48	x
GRAND SCENIC III	MPV 7seats	31105/C	JZ	02/09	08/16	x	i	C	1480	75	8,80	279,84	x
GRAND SCENIC III	MPV 7seats	31105/VM	JZ	02/09	08/16	x	i	VM	1480	75	8,80	349,80	x
GRAND SCENIC IV	MPV 7seats	31109/F	RFA	09/16		x	i	F	2087	80	11,10	204,58	
GRAND SCENIC IV	MPV 7seats	31109/C	RFA	09/16		x	i	C	2087	80	11,10	312,70	
GRAND SCENIC IV	MPV 7seats	31109/VM	RFA	09/16		x	i	VM	2087	80	11,10	373,12	
KADJAR	2-4WD, AdBlue	31106/F	RF	06/15	10/18	x		F	2018	90	10,00	192,92	x
KADJAR	2-4WD, AdBlue	31106/C	RF	06/15	10/18	x		C	2018	90	10,00	299,98	x
KADJAR	2-4WD, AdBlue	31106/VM	RF	06/15	10/18	x		VM	2018	90	10,00	347,68	x
KADJAR	2-4WD, AdBlue	31106/F	RF	11/18		x		F	2018	90	10,00	192,92	x
KADJAR	2-4WD, AdBlue	31106/C	RF	11/18		x		C	2018	90	10,00	299,98	x
KADJAR	2-4WD, AdBlue	31106/VM	RF	11/18		x		VM	2018	90	10,00	347,68	x
KANGOO	MPV 4x4	31098/F	FC??A8, KC??A8, KC??AK, FC??AK	01/97	12/07			F	1200	75	8,60	184,44	x
KANGOO	MPV 4x4	31098/C	FC??A8, KC??A8, KC??AK, FC??AK	01/97	12/07			C	1200	75	8,60	297,86	x
KANGOO	MPV no 4X4, no GRANVOLUME L=4.320	31096/F	FC, KC, F1	01/97	12/07			F	1355	75	8,60	178,08	x
KANGOO	MPV no 4X4, no GRANVOLUME L=4.320	31096/C	FC, KC, F1	01/97	12/07			C	1355	75	8,60	284,08	x
KANGOO	MPV, BE-BOP, MAXI, VAN	31102/F	FW, KW, W-A, RK, RF	01/08	03/21			F	1355	75	8,00	184,44	x















													
KANGOO	MPV, BE-BOP, MAXI, VAN	31102/C	FW, KW, W-A, RK, RF	01/08	03/21			C	1355	75	8,00	291,50	x
KANGOO	MPV, BE-BOP, MAXI, VAN	31102/VM	FW, KW, W-A, RK, RF	01/08	03/21			VM	1355	75	8,00	412,34	x
KANGOO EXPRESS Z.E.	MPV, check towing capacity, no 5 seats Z.E.	31115/F	FW	01/20				F	1355	75	8,00	320,00	x
KANGOO EXPRESS Z.E.	MPV, check towing capacity, no 5 seats Z.E.	31115/C	FW	01/20				C	1355	75	8,00	375,00	x
KANGOO EXPRESS Z.E.	MPV, check towing capacity, no 5 seats Z.E.	31115/VM	FW	01/20				VM	1355	75	8,00	410,00	x
KANGOO	MPV, VAN	31113/1F	RFK	03/21		x	i	F	1737	90	9,60	206,70	x
KANGOO	MPV, VAN	31113/1C	RFK	03/21		x	i	C	1737	90	9,60	280,90	x
KANGOO	MPV, VAN	31113/1VM	RFK	03/21		x	i	VM	1737	90	9,60	365,70	x
KOLEOS	SUV 4WD	31090/F	VY	09/08	03/17	x		F	2000	100	11,20	208,82	x
KOLEOS	SUV 4WD	31090/C	VY	09/08	03/17	x		C	2000	100	11,20	244,86	x
KOLEOS	SUV 4WD	31090/VM	VY	09/08	03/17	x		VM	2000	100	11,20	339,20	x
LAGUNA GRANDTOUR	ESTATE	31072/C	KG	01/01	06/07			C	1500	75	9,00	301,04	x
LAGUNA II	HATCHBACK 5 doors	31073/F	BG	01/01	06/07			F	1500	75	9,00	174,90	x
LAGUNA II	HATCHBACK 5 doors	31073	BG	01/01	06/07			C	1500	75	9,00	309,52	x
LAGUNA III	HATCHBACK 5 doors, no coupé	31088/F	BT	07/07			i	F	1500	75	9,20	215,18	x
LAGUNA III	HATCHBACK 5 doors, no coupé	31088/C	BT	07/07			i	C	1500	75	9,20	311,64	x
LAGUNA III	HATCHBACK 5 doors, no coupé	31088/VM	BT	07/07			i	VM	1500	75	9,20	355,10	x
LAGUNA III SPORTOUR	ESTATE	31087/F	KT	01/08			i	F	1500	75	9,20	215,18	x
LAGUNA III SPORTOUR	ESTATE	31087/C	KT	01/08			i	C	1500	75	9,20	311,64	x
LAGUNA III SPORTOUR	ESTATE	31087/VM	KT	01/08			i	VM	1500	75	9,20	355,10	x
MASTER II	VAN, Restyling	31101/SF	ED, FD, JD, ND, PD, E9, F3, F9	01/98	02/10			SF	2300	100	13,80	238,50	x
MASTER II	VAN, Restyling	31101/G	ED, FD, JD, ND, PD, E9, F3, F9	01/98	02/10			G	2300	100	13,80	443,08	x
MASTER III	VAN front wheel drive only	31104/SF	MA, MR, M9A, MF, MW, M9, M1, MS, ML, VA, V1	03/10				SF	3076	120	15,00	258,64	x
MASTER III	VAN front wheel drive only	31104/G	MA, MR, M9A, MF, MW, M9, M1, MS, ML, VA, V1	03/10				GRIFO	3076	120	15,00	434,60	x
MEGANE I	HATCHBACK 5 doors	31061	BA	01/96	10/02	x		C	1300	75	7,67	240,62	x
MEGANE I CLASSIC	Saloon 4 doors	31060	LA	01/96		x		C	1300	75	7,67	305,28	x
MEGANE I COACH	COUPÉ	31062	DA	01/96	03	x		C	1300	75	7,67	279,84	x
MEGANE I GRANDTOUR	ESTATE	31069	KA	99	03			C	1350	55	7,80	301,04	x
MEGANE II	HATCHBACK 3-5 doors, no CABRIO	31105/F	BM, CM	11/02	10/08	x	i	F	1480	75	8,80	220,48	x
MEGANE II	HATCHBACK 3-5 doors, no CABRIO	31105/C	BM, CM	11/02	10/08	x	i	C	1480	75	8,80	279,84	x
MEGANE II	HATCHBACK 3-5 doors, no CABRIO	31105/VM	BM, CM	11/02	10/08	x	i	VM	1480	75	8,80	349,80	x
MEGANE II	Saloon, no CABRIO	31079/F	LM, KM	09/03	09	x		F	1350	75	8,50	220,48	x
MEGANE II	Saloon, no CABRIO	31079/C	LM, KM	09/03	09	x		C	1350	75	8,50	307,40	x
MEGANE II GRANDTOUR	ESTATE	31079/F	LM, KM	09/03	06/09	x		F	1350	75	8,50	220,48	x















																
MEGANE II GRANDTOUR	ESTATE	31079/C	LM, KM	09/03	06/09	x		C	1350	75	8,50	307,40		x		
MEGANE III	HATCHBACK 3-5 doors, no CABRIO	31105/C	BZ, DZ	11/08	12/15	x	i	C	1480	75	8,80	279,84		x		
MEGANE III	HATCHBACK 3-5 doors, no CABRIO	31105/VM	BZ, DZ	11/08	12/15	x	i	VM	1480	75	8,80	349,80		x		
MEGANE IV	HATCHBACK 5 doors	31107/F	RFB	01/16		x	i	F	2232	75	10,00	192,92		x		
MEGANE IV	HATCHBACK 5 doors	31107/C	RFB	01/16		x	i	C	2232	75	10,00	268,18		x		
MEGANE IV	HATCHBACK 5 doors	31107/VM	RFB	01/16		x	i	VM	2232	75	10,00	344,50		x		
MEGANE SCENIC	MPV, no JA ???E	31059/F	JA	97	06/03			F	1300	75	8,00	184,44	x			
MEGANE SCENIC	MPV, no JA ???E	31059	JA	97	06/03			C	1300	75	8,00	307,40	x			
MEGANE III SPORTOUR	ESTATE, GT LINE, check D value	31093/F	KZ	07/09	03/16	x		F	1500	75	8,10	220,48		x		
MEGANE III SPORTOUR	ESTATE, GT LINE, check D value	31093/C	KZ	07/09	03/16	x		C	1500	75	8,10	270,30		x		
MEGANE III SPORTOUR	ESTATE, GT LINE, check D value	31093/VM	KZ	07/09	03/16	x		VM	1500	75	8,10	365,70		x		
MEGANE SPORTER IV	ESTATE, GT LINE	31108/F	RFB	04/16		x	i	F	2451	75	10,60	192,92		x		
MEGANE SPORTER IV	ESTATE, GT LINE	31108/C	RFB	04/16		x	i	C	2451	75	10,60	268,18		x		
MEGANE SPORTER IV	ESTATE, GT LINE	31108/VM	RFB	04/16		x	i	VM	2451	75	10,60	344,50		x		
MODUS	MPV L=3.792, no NEW MODUS, no GRAND MODUS (L>=3.874), no MARGATE 106 CV	31082	JP, FP	11/04	12/07		i	C	900	75	6,40	288,32		x		
MODUS	GRAND MODUS MPV L>=3.874, without spare wheel under the panel, NEW MPV	31097/F	JP	01/08			i	F	900	80	7,50	201,40		x		
MODUS	GRAND MODUS MPV L>=3.874, without spare wheel under the panel, NEW MPV	31097/C	JP	01/08			i	C	900	80	7,50	295,74		x		
MODUS	GRAND MODUS MPV L>=3.874, without spare wheel under the panel, NEW MPV	31097/VM	JP	01/08			i	VM	900	80	7,50	386,90		x		
R 4 - F 4	CARGO	31001		72		x		F	560			227,90	x			
SCENIC	RX4 MPV	31071/F	JA???E	99	03			F	1300	75	8,40	174,90		x		
SCENIC	RX4 MPV	31071/C	JA???E	00	03			C	1300	75	8,40	331,78		x		
SCENIC II	MPV 5 seats	31105/F	JM	06/03	01/09	x		F	1480	75	8,80	220,48		x		
SCENIC II	MPV 5 seats	31105/C	JM	06/03	01/09	x	i	C	1480	75	8,80	279,84		x		
SCENIC II	MPV 5 seats	31105/VM	JM	06/03	01/09	x	i	VM	1480	75	8,80	349,80		x		
SCENIC III	MPV 5 seats, X-MODE, check D value	31105/F	JZ	02/09	08/16	x	i	F	1480	75	8,80	220,48		x		
SCENIC III	MPV 5 seats, X-MODE, check D value	31105/C	JZ	02/09	08/16	x	i	C	1480	75	8,80	279,84		x		
SCENIC III	MPV 5 seats, X-MODE, check D value	31105/VM	JZ	02/09	08/16	x	i	VM	1480	75	8,80	349,80		x		
SCENIC IV	MPV 5 seats	31109/F	RFA	09/16		x	i	F	2087	80	11,10	204,58				
SCENIC IV	MPV 5 seats	31109/C	RFA	09/16		x	i	C	2087	80	11,10	312,70				
SCENIC IV	MPV 5 seats	31109/VM	RFA	09/16		x	i	VM	2087	80	11,10	373,12				
TALISMAN	SALOON	31110/F	RFD	01/16		x	i	F	2000	100	10,20	204,58				
TALISMAN	SALOON	31110/C	RFD	01/16		x	i	C	2000	100	10,20	314,82				
TALISMAN	SALOON	31110/VM	RFD	01/16		x	i	VM	2000	100	10,20	360,40				
TALISMAN GRANDTOUR	ESTATE	31110/F	RFD	03/16		x	i	F	2000	100	10,20	204,58				
TALISMAN GRANDTOUR	ESTATE	31110/C	RFD	03/16		x	i	C	2000	100	10,20	314,82				
TALISMAN GRANDTOUR	ESTATE	31110/VM	RFD	03/16		x	i	VM	2000	100	10,20	360,40				
TRAFIC	VAN, Restyling	31099/SF	F7, FL, JL	01/01	10/14			SF	2000	80	12,50	190,80	x			
TRAFIC	VAN, Restyling	31075	F7, FL, JL	01/01	10/14			C	2000	80	12,50	219,42	x			















													
TRAFIC	VAN, check D value	31103/SF	L, X83, F7, JL	10/14				SF	2366	120	12,50	190,80	x
TRAFIC	VAN, check D value	31103/G	L, X83, F7, JL	10/14				GRIFO	2366	120	12,50	471,70	x
TWINGO	HATCHBACK 3 doors	31065	C06, S06	94	07	x	v	C	600	25	4,40	223,66	x
TWINGO II	HATCHBACK 3 doors, Restyling	31084	CN	08/07	07/14	x	v	C	715	65	4,80	253,34	x
ROVER													
ROVER 200	HATCHBACK 3-5 doors	03019	RF	96		x	v	C	1535	65	6,50	295,74	x
ROVER 25	HATCHBACK 3-5 doors	03019	RF	96		x		C	1535	65	6,50	295,74	x
SEAT													
ALHAMBRA	4X4 MPV 1st SERIES	14063/1F	7MS	96	01/99	x	v	F	2085	85	11,66	221,54	x
ALHAMBRA	4X4 MPV 2nd SERIES	14063/2F	7MS	00	08/10	x		F	2085	85	11,66	221,54	x
ALHAMBRA	MPV, invisible bumper cut with original flap 7NO 807 521A, no 4WD (7N????X1)	33022/F	7N	09/10		x	v	F	2200	100	12,00	171,72	x
ALHAMBRA	MPV, invisible bumper cut with original flap 7NO 807 521A, no 4WD (7N????X1)	33022/C	7N	09/10		x	v	C	2200	100	12,00	256,52	x
ALHAMBRA	MPV, invisible bumper cut with original flap 7NO 807 521A, no 4WD (7N????X1)	33022/VM	7N	09/10		x	v	VM	2200	100	12,00	338,14	x
ALTEA	MPV, no ALTEA XL (5PAC)	33019/F	5P AF	03/04		x	v	F	1400	75	9,00	160,06	x
ALTEA	MPV, no ALTEA XL (5PAC)	33019/C	5P AF	03/04		x	v	C	1400	75	9,00	254,40	x
ALTEA	MPV, no ALTEA XL (5PAC)	33019/VM	5P AF	03/04		x	v	VM	1400	75	9,00	338,14	x
ALTEA XL	MPV, no FREETRACK	33020/F	5P AC	09/06		x	v	F	1400	75	9,00	171,72	x
ALTEA XL	MPV, no FREETRACK	33020/C	5P AC	09/06		x	v	C	1400	75	9,00	254,40	x
ALTEA XL	MPV, no FREETRACK	33020/VM	5P AC	09/06		x	v	VM	1400	75	9,00	338,14	x
ARONA	CROSSOVER	33025/F	KJ	11/17		x		F	1357	55	7,50	174,90	x
ARONA	CROSSOVER	33025/C	KJ	11/17		x		C	1357	55	7,50	279,84	x
ARONA	CROSSOVER	33025/VM	KJ	11/17		x		VM	1357	55	7,50	328,60	x
AROSA	HATCHBACK 3 doors	43044	6H	01/97		x	v	C	800	50	5,50	299,98	x
ATECA	2-4WD, AdBlue	33026/F	5FP	06/16		x		F	2575	100	12,20	163,24	x
ATECA	2-4WD, AdBlue	33023/C	5FP	06/16		x		C	2575	100	12,20	262,88	x
ATECA	2-4WD, AdBlue	33023/VM	5FP	06/16		x		VM	2575	100	12,20	318,00	x
CORDOBA	Saloon 2-4 doors, check bumper	33013	6K5, 6K6	01/94	96			C	1100	50		278,78	x
CORDOBA	Saloon	33015/F	6K SC, 6K ST	96	12/02	x	v	F	1100	50	7,00	209,88	x
CORDOBA	Saloon	33015	6K SC, 6K ST	96	12/02	x	v	C	1100	50	7,00	294,68	x
CORDOBA VARIO	ESTATE	43043	6K SE	96		x	v	C	1000	50	7,00	329,66	x
EXEO	Saloon, ESTATE	02027/1F	3R	02/09		x	i	F	1800	80	10,50	160,06	x
EXEO	Saloon, ESTATE	02027/1C	3R	02/09		x	i	C	1800	80	10,50	288,32	x
EXEO	Saloon, ESTATE	02027/1VM	3R	02/09		x	i	VM	1800	80	10,50	361,46	x
IBIZA	HATCHBACK 3-5 doors, no GTI, check bumper	33012	6K3, 6K4	93	96			C	1100	50		270,30	x
IBIZA	HATCHBACK, check bumper	33015	6KSC, 6KST	96	06/02	x	v	C	1100	50	7,00	294,68	x
IBIZA	HATCHBACK, check bumper	33015/F	6KSC, 6KST	96	06/02	x	v	F	1100	50	7,00	209,88	x
IBIZA	HATCHBACK 3-5 doors, no FR, no CUPRA	33017	6LSC	06/02	06/08	x	v	C	1200	50	7,50	279,84	x
IBIZA	HATCHBACK 3-5 doors	33021/F	6J	07/08	07/15	x	v	F	1200	50	7,30	171,72	x
IBIZA	HATCHBACK 3-5 doors	33021/C	6J	07/08	07/15	x	v	C	1200	50	7,30	244,86	x
IBIZA	HATCHBACK 3-5 doors	33021/VM	6J	07/08	07/15	x	v	VM	1200	50	7,30	338,14	x
IBIZA	HATCHBACK 3-5 doors, AdBlue	33024/F	KJ	01/17		x		F	1457	75	7,80	192,92	x
IBIZA	HATCHBACK 3-5 doors, AdBlue	33024/C	KJ	01/17		x	i	C	1457	75	7,80	303,16	x
IBIZA	HATCHBACK 3-5 doors, AdBlue	33024/VM	KJ	01/17		x	i	VM	1457	75	7,80	355,10	x















													
IBIZA	ESTATE	33021/F	6J	06/10	07/15	x	v	F	1200	50	7,30	171,72	x
IBIZA	ESTATE	33021/C	6J	06/10	07/15	x	v	C	1200	50	7,30	244,86	x
IBIZA	ESTATE	33021/VM	6J	06/10	07/15	x	v	VM	1200	50	7,30	338,14	x
LEON	HATCHBACK 3-5 doors, no 4X4	34001	1M AB(X0)	01/00	07/05	x	v	C	1400	60	8,00	294,68	x
LEON	HATCHBACK 3-5 doors, no 4X4	34001/F	1M AB(X0)	01/00	07/05	x	v	F	1400	60	8,00	181,26	
LEON	HATCHBACK 5 doors, no SPORT bumper kit	33019/F	1P AF	08/05	10/12	x	v	F	1400	75	9,00	160,06	x
LEON	HATCHBACK 5 doors, no SPORT bumper kit	33019/C	1P AF	08/05	10/12	x	v	C	1400	75	9,00	254,40	x
LEON	HATCHBACK 5 doors, no SPORT bumper kit	33019/VM	1P AF	08/05	10/12	x	v	VM	1400	75	9,00	338,14	x
LEON	HATCHBACK 3-5 doors, ESTATE, TGI	02033/F	5F	11/12	10/16	x	v	F	2190	80	10,35	147,34	x
LEON	HATCHBACK 3-5 doors, ESTATE, TGI	02033/C	5F	11/12	10/16	x	v	C	2190	80	10,35	270,30	x
LEON	HATCHBACK 3-5 doors, ESTATE, TGI, invisible bumper cut with original flap	02033/VM	5F	11/12	10/16	x	v	VM	2190	80	10,35	338,14	x
LEON	HATCHBACK 5 doors, FR	43070/F	KL	11/19		x		F	2575	100	12,20	159,00	x
LEON	HATCHBACK 5 doors, FR	43070/C	KL	11/19		x		C	2575	100	12,20	265,00	x
LEON	HATCHBACK 5 doors, FR	43070/VM	KL	11/19		x		VM	2575	100	12,20	371,00	x
LEON	E-HYBRID	43071/F	KL	11/19		x		F	2575	100	12,20	233,20	x
LEON	E-HYBRID	43071/C	KL	11/19		x		C	2575	100	12,20	328,60	x
LEON	E-HYBRID	43071/VM	KL	11/19		x		VM	2575	100	12,20	445,20	x
LEON III ST	ESTATE	43070/F	5F	01/17	03/20	x		F	2575	100	12,20	159,00	x
LEON III ST	ESTATE	43070/C	5F	01/17	03/20	x		C	2575	100	12,20	265,00	x
LEON III ST	ESTATE	43070/VM	5F	01/17	03/20	x		VM	2575	100	12,20	371,00	x
LEON IV ST	ESTATE	43070/F	5F	04/20		x		F	2575	100	12,20	159,00	x
LEON IV ST	ESTATE	43070/C	5F	04/20		x		C	2575	100	12,20	265,00	x
LEON IV ST	ESTATE	43070/VM	5F	04/20		x		VM	2575	100	12,20	371,00	x
LEON FR	HATCHBACK 3-5 doors	02033/F	5F	11/12	10/16	x	v	F	2190	80	10,35	147,34	x
LEON FR	HATCHBACK 3-5 doors	02033/C	5F	11/12	10/16	x	v	C	2190	80	10,35	270,30	x
LEON FR	HATCHBACK 3-5 doors, invisible bumper cut with original flap	02033/VM	5F	11/12	10/16	x	v	VM	2190	80	10,35	338,14	x
TARRACO	2-4WD	33023/F	KN	09/18		x		F	2575	100	12,20	163,24	x
TARRACO	2-4WD	33023/C	KN	09/18		x		C	2575	100	12,20	262,88	x
TARRACO	2-4WD	33023/VM	KN	09/18		x		VM	2575	100	12,20	318,00	x
TOLEDO II	Saloon 4 doors	33016	1MAA	01/99	12/04	x	v	C	1500	75	8,50	267,12	x
TOLEDO III	MPV	33020/F	5P AB	01/05	09/12	x	v	F	1400	75	9,00	171,72	x
TOLEDO III	MPV	33020/C	5P AB	01/05	09/12	x	v	C	1400	75	9,00	254,40	x
TOLEDO III	MPV	33020/VM	5P AB	01/05	09/12	x	v	VM	1400	75	9,00	338,14	x
SKODA													
FABIA	Saloon, HATCHBACK	34007/1C	5JAB	01/00	10/14	x	v	C	1000	50	7,50	258,64	x
FABIA	WAGON	34007/1C	6Y	01/00	01/08	x	v	C	1000	50	7,50	258,64	x
FABIA	WAGON	34007/2C	5JAC	02/08	10/14	x	v	C	1200	50	7,50	258,64	x
FELICIA	HATCHBACK	34003	E, 791 SC, 791 AB	01/94				C	1000	50	6,30	263,94	x
KAMIQ	CROSSOVER	34013/F	NW	01/19		x	i	F	1400	75	7,80	150,00	x
KAMIQ	CROSSOVER	34013/C	NW	01/19		x	i	C	1400	75	7,80	250,00	x
KAMIQ	CROSSOVER	34013/VM	NW	01/19		x	i	VM	1400	75	7,80	365,00	x
KAROQ	2-4WD, AdBlue	33023/F	NU	07/17		x	i	F	2575	100	12,20	163,24	x















													
KAROQ	2-4WD, AdBlue	33023/C	NU	07/17		x	i	C	2575	100	12,20	262,88	x
KAROQ	2-4WD, AdBlue	33023/VM	NU	07/17		x	i	VM	2575	100	12,20	318,00	x
KODIAQ	2-4WD, AdBlue	33023/F	NS	04/17		x	i	F	2575	100	12,20	163,24	x
KODIAQ	2-4WD, AdBlue	33023/C	NS	04/17		x	v	C	2575	100	12,20	262,88	x
KODIAQ	2-4WD, AdBlue	33023/VM	NS	04/17		x	v	VM	2575	100	12,20	318,00	x
OCTAVIA	Saloon, WAGON, no 4x4	34001/F	1U???X01	01/96	06/04	x	i	F	1300	60	8,00	181,26	x
OCTAVIA	Saloon, WAGON, no 4x4	34001	1U???X01	01/96	06/04	x	i	C	1300	60	8,00	294,68	x
OCTAVIA	Saloon, WAGON, 4X4	34006/F	1Z	07/04	05/13	x	i	F	1600	75	9,30	166,42	x
OCTAVIA	Saloon, WAGON, 4X4	34006/C	1Z	07/04	05/13	x	i	C	1600	75	9,30	261,82	x
OCTAVIA	Saloon, WAGON, 4X4	34006/VM	1Z	07/04	05/13	x	i	VM	1600	75	9,30	355,10	x
OCTAVIA	Saloon, WAGON, 4X4	34010/F	5E	06/13	01/20	x	i	F	1800	75	10,60	181,26	x
OCTAVIA	Saloon, WAGON, 4X4	34010/C	5E	06/13	01/20	x	i	C	1800	75	10,60	288,32	x
OCTAVIA	Saloon, WAGON, 4X4	34010/VM	5E	06/13	01/20	x	i	VM	1800	75	10,60	338,14	x
OCTAVIA	WAGON 4X4, 4&4	34005/F	1U???X11	01/96	06/04	x	i	F	1500	65	9,00	153,70	x
OCTAVIA	WAGON 4X4, 4&4	34005/C	1U???X11	01/96	06/04	x	i	C	1500	65	9,00	270,30	x
OCTAVIA	WAGON 4X4, 4&4	34005/VM	1U???X11	01/96	06/04	x	i	VM	1500	65	9,00	339,20	x
RAPID	Saloon	34011/F	NH	10/12		x	i	F	1757	50	8,70	171,72	x
RAPID	Saloon	34011/C	NH	10/12		x	i	C	1757	50	8,70	270,30	x
RAPID	Saloon	34011/VM	NH	10/12		x	i	VM	1757	50	8,70	323,30	x
RAPID SPACEBACK	ESTATE	34011/F	NH	10/12		x	i	F	1757	50	8,70	171,72	x
RAPID SPACEBACK	ESTATE	34011/C	NH	10/12		x	i	C	1757	50	8,70	270,30	x
RAPID SPACEBACK	ESTATE	34011/VM	NH	10/12		x	i	VM	1757	50	8,70	323,30	x
ROOMSTER	MPV	34008/C	5J	07/06		x	v	C	1200	50	7,40	286,20	x
SUPERB	Saloon, no 4x4	43041/F	3U	01/02	08/08	x		F	1600	85	9,66	151,58	x
SUPERB	Saloon, no 4x4	43041	3U	01/02	08/08	x		C	1600	85	9,66	189,74	x
SUPERB	Saloon	43064/F	3T	09/08	05/15	x	i	F	2050	75	10,60	160,06	x
SUPERB	Saloon	43064/C	3T	09/08	05/15	x	i	C	2050	75	10,60	284,08	x
SUPERB	Saloon	43064/VM	3T	09/08	05/15	x	i	VM	2050	75	10,60	375,24	x
SUPERB	Saloon	43063/F	3T	06/15		x	i	F	2652	90	12,00	196,10	x
SUPERB	Saloon	43063/C	3T	06/15		x	i	C	2652	90	12,00	288,32	x
SUPERB	Saloon	43063/VM	3T	06/15		x	i	VM	2652	90	12,00	380,54	x
SUPERB WAGON	WAGON	43064/F	3T	09/08	08/15	x	i	F	2050	75	10,60	160,06	x
SUPERB WAGON	WAGON	43064/C	3T	09/08	08/15	x	i	C	2050	75	10,60	284,08	x
SUPERB WAGON	WAGON	43064/VM	3T	09/08	08/15	x	i	VM	2050	75	10,60	375,24	x
SUPERB WAGON	WAGON	43063/F	3T	09/15		x	i	F	2652	90	12,00	196,10	x
SUPERB WAGON	WAGON	43063/C	3T	09/15		x	i	C	2652	90	12,00	288,32	x
SUPERB WAGON	WAGON	43063/VM	3T	09/15		x	i	VM	2652	90	12,00	380,54	x
YETI	MPV, Restyling '14	43064/F	5L	11/09		x	i	F	2050	75	10,60	160,06	x
YETI	MPV, Restyling '14	43064/C	5L	11/09		x	i	C	2050	75	10,60	284,08	x
YETI	MPV, Restyling '14, the nozzle can be slightly seen	43064/VM	5L	11/09		x	i	VM	2050	75	10,60	375,24	x
SMART													
FORFOUR	HATCHBACK 5 doors	34101	454	06/04	01/14	x	i	C	750	50	5,20	347,68	x
SSANGYONG													
ACTYON	no ACTYON SPORT	34203/F	CJ	06/06				F	2300	92	12,00	208,82	x
ACTYON	no ACTYON SPORT	34203/SF	CJ	06/06				SF(C)	2300	92	12,00	328,60	x
ACTYON	no ACTYON SPORT	34203/C	CJ	06/06				C	2300	92	12,00	312,70	x















														
ACTYON	no ACTYON SPORT	34203/G	CJ	06/06					GRIFO(C)	2300	92	12,00	489,72	x
ACTYON	no ACTYON SPORT	34203/VM	CJ	06/06					VM	2300	92	12,00	395,38	x
ACTYON SPORT	PICK-UP 2-4WD	34207/SF	UQJ	01/20 06	01/20 12				SF	2381	150	12,50	221,54	
ACTYON SPORT	PICK-UP 2-4WD	34207/G	UQJ	01/20 06	01/20 12				G	2381	150	12,50	326,48	
ACTYON SPORT	PICK-UP 2-4WD	34207/SFM	UQJ	01/20 06	01/20 12				SFM	2381	150	12,50	376,30	
ACTYON SPORT	PICK-UP 2-4WD	34207/SF	UQJ	01/20 12					SF	2381	150	12,50	221,54	
ACTYON SPORT	PICK-UP 2-4WD	34207/G	UQJ	01/20 12					G	2381	150	12,50	326,48	
ACTYON SPORT	PICK-UP 2-4WD	34207/SFM	UQJ	01/20 12					SFM	2381	150	12,50	376,30	
KORANDO	SUV 2-4WD, LPG	34204/F	CK	10/10	08/19		i	F	2000	75	11,00	135,68	x	
KORANDO	SUV 2-4WD, LPG	34204/C	CK	10/10	08/19		i	C	2000	75	11,00	230,02	x	
KORANDO	SUV 2-4WD, LPG	34204/VM	CK	10/10	08/19		i	VM	2000	75	11,00	338,14	x	
KORANDO	SUV 2-4WD, LPG, AdBlue	34208/F	CW	09/19		x	i	F	2235	105	11,00	139,92	x	
KORANDO	SUV 2-4WD, LPG, AdBlue	34208/C	CW	09/19		x	i	C	2235	105	11,00	286,20	x	
KORANDO	SUV 2-4WD, LPG, AdBlue	34208/VM	CW	09/19		x	i	VM	2235	105	11,00	355,10	x	
KYRON	SUV 4WD	34202/F	DJ	11/05		x	v	F	3500	140	14,95	233,20	x	
KYRON	SUV 4WD	34202/C	DJ	11/05		x	v	C	3500	140	14,95	319,06	x	
KYRON	SUV 4WD	34202/VM	DJ	11/05		x	v	VM	3500	140	14,95	371,00	x	
MUSSO GRAND	PICK-UP	34210/C	QK B	01/21				C	3486	150	16,50	360,40	x	
MUSSO GRAND	PICK-UP	34210/SF	QK B	01/21				SF(C)	3486	150	16,50	360,40	x	
MUSSO GRAND	PICK-UP	34210/G	QK B	01/21				GRIFO(C)	3486	150	16,50	471,70	x	
MUSSO GRAND	PICK-UP	34210/SFM	QK B	01/21				SFM(C)	3486	150	16,50	551,20	x	
REXTON	4WD, Restyling '13	34202/F	RJ	01/02	09/17	x	v	F	3500	140	14,95	233,20	x	
REXTON	4WD, Restyling '13	34202/C	RJ	01/02	09/17	x	v	C	3500	140	14,95	319,06	x	
REXTON	4WD, Restyling '13	34202/VM	RJ	01/02	09/17	x	v	VM	3500	140	14,95	371,00	x	
REXTON	2-4 WD	34206/F	YK, YKM	10/17	12/20	x		F	3795	140	16,00	233,20	x	
REXTON	2-4 WD	34206/C	YK, YKM	10/17	12/20	x		C	3795	140	16,00	314,82	x	
REXTON	2-4 WD	34206/VM	YK, YKM	10/17	12/20	x		VM	3795	140	16,00	355,10	x	
REXTON	2-4 WD	34211/F	YK	01/21		x		F	3795	140	16,00	259,70	x	
REXTON	2-4 WD	34211/C	YK	01/21		x		C	3795	140	16,00	312,70	x	
REXTON	2-4 WD, the VM device remains visible	34211/VM	YK	01/21		x		VM	3795	140	16,00	386,90	x	
REXTON	2-4 WD	34212/C	YK	01/21		x		C	3795	140	16,00	339,20	x	
REXTON	2-4 WD	34212/SF	YK	01/21		x		SF(C)	3795	140	16,00	339,20	x	
REXTON	2-4 WD	34212/G	YK	01/21		x		GRIFO(C)	3795	140	16,00	471,70	x	
REXTON	2-4 WD	34212/SFM	YK	01/21		x		SFM(C)	3795	140	16,00	551,20	x	
REXTON SPORTS	2-4 WD Pick-Up	34206/F	QK	07/18	06/20	x		F	3795	140	16,00	233,20	x	
REXTON SPORTS	2-4 WD Pick-Up	34206/C	QK	07/18	06/20	x		C	3795	140	16,00	314,82	x	
REXTON SPORTS	2-4 WD Pick-Up	34206/VM	QK	07/18	06/20	x		VM	3795	140	16,00	355,10	x	
REXTON SPORTS	PICK-UP	34210/C	QK	07/20	12/22			C	3486	150	16,50	360,40	x	
REXTON SPORTS	PICK-UP	34210/SF	QK	07/20	12/22			SF(C)	3486	150	16,50	360,40	x	
REXTON SPORTS	PICK-UP	34210/G	QK	07/20	12/22			GRIFO(C)	3486	150	16,50	471,70	x	















													
REXTON SPORTS	PICK-UP	34210/SFM	QK	07/20	12/22			SFM(C)	3486	150	16,50	551,20	x
TIVOLI	2-4WD	34205/F	XK	07/15	05/19			F	1756	60	9,00	209,88	x
TIVOLI	2-4WD	34205/C	XK	07/15	05/19			C	1756	60	9,00	284,08	x
TIVOLI	2-4WD, AdBlue	34209/F	XK	06/19		x		F	1641	60	9,00	243,80	x
TIVOLI	2-4WD, AdBlue	34209/C	XK	06/19		x		C	1641	60	9,00	307,40	x
XLV	2-4WD	34205/F	XK, XKG	11/16				F	1756	60	9,00	209,88	x
XLV	2-4WD	34205/C	XK, XKG	11/16				C	1756	60	9,00	284,08	x
SUBARU													
FORESTER	SUV	35001	SF	01/97	12/02	x	v	C	1500	75	9,00	321,18	x
FORESTER	SUV	35002	SG, SGG	01/03	04/08			C	1800	75	9,70	352,98	x
FORESTER	SUV	35005/F	SH, SJ	05/08	08/19	x	v	F	2000	80	10,50	208,82	x
FORESTER	SUV	35005/C	SH, SJ	05/08	08/19	x	v	C	2000	80	10,50	319,06	x
FORESTER	SUV	35005/VM	SH, SJ	05/08	08/19	x	v	VM	2000	80	10,50	381,60	x
FORESTER	SUV	35010/F	S5	09/19		x	i	F	2182	100	10,50	232,14	x
FORESTER	SUV	35010/C	S5	09/19		x	i	C	2182	100	10,50	309,52	x
IMPREZA	Saloon	35003	GD/GG, GF, GC/GF	93	07/07	x		C	1600	75	8,80	342,38	x
IMPREZA WAGON	ESTATE	35003	GD/GG, GF, GC/GF	01	08/05	x		C	1600	75	8,80	342,38	x
JUSTY III	G3X MPV 4WD	37018/C	NH	01/04	12/07			C	800	50	6,00	333,90	x
JUSTY III	G3X MPV 4WD	37018/F	NH	01/04	12/07			F	800	50	6,00	216,24	x
LEGACY OUTBACK	ESTATE	35007/F	BL/BP	09/03	09/09	x	i	F	2214	85	10,20	238,50	x
LEGACY OUTBACK	ESTATE	35007/C	BL/BP	09/03	09/09	x	i	C	2214	85	10,20	329,66	x
LEGACY OUTBACK	ESTATE	35007/VM	BL/BP	09/03	09/09	x	i	VM	2214	85	10,20	397,50	x
XV	2-4WD	35006/F	G4	03/12	11/17	x	i	F	1761	75	9,10	208,82	x
XV	2-4WD	35006/C	G4	03/12	11/17	x	i	C	1761	75	9,10	307,40	x
XV	4WD	35008/F	G4, G5	12/17		x		F	1760	90	9,10	216,24	
XV	4WD	35008/C	G4, G5	12/17		x		C	1760	90	9,10	321,18	
XV	4WD	35008/VM	G4, G5	12/17		x		VM	1760	90	9,10	379,48	
XV	4WD, HYBRID	35011/F	G4, G5	12/17		x		F	1760	90	9,10	233,20	
XV	4WD, HYBRID	35011/C	G4, G5	12/17		x		C	1760	90	9,10	318,00	
XV	4WD, HYBRID	35011/VM	G4, G5	12/17		x		VM	1760	90	9,10	408,10	
SUZUKI													
ACROSS	HYBRID	39043/F	XA5	06/20		x	i	F	2234	70	11,00	239,56	x
ACROSS	HYBRID	39043/C	XA5	06/20		x	i	C	2234	70	11,00	307,40	x
ACROSS	HYBRID	39043/VM	XA5	06/20		x	i	VM	2234	70	11,00	386,90	x
ALTO	HATCHBACK	37015	FF	02	09			C	750	30	5,20	288,32	x
GRAND VITARA	4WD 3-5 doors XL-7, CABRIO	37020	FT, GT, HT	04/98	09/05			C	1850	75	11,00	294,68	x
GRAND VITARA	SHORT 2doors 4WD, Restyling '13	37022/2	JTA	10/05	03/15		i	C	1600	85	10,50	322,24	x
GRAND VITARA	LONG 4 doors 4WD, Restyling '13	37022/4	JTD	10/05	03/15		i	C	2000	85	10,50	322,24	x
IGNIS	MPV 3-5 doors 2-4WD	37013	FH	01/01	09/03		v	C	800	50	5,80	288,32	x
IGNIS II	MPV 2-4WD	37018/F	MH	10/03	12/16			F	800	50	6,00	216,24	x
IGNIS II	MPV 2-4WD	37018/C	MH	10/03	12/16			C	800	50	6,00	333,90	x
IGNIS	2WD, no 4x4	37028/F	MF H	01/17				F	1241	50	6,30	178,08	x
IGNIS	2WD, no 4x4	37028/C	MF H	01/17				C	1241	50	6,30	294,68	x
IGNIS	2WD, HYBRID	37033/F	MF H	01/17				F	1241	50	6,30	206,70	x
IGNIS	2WD, HYBRID	37033/C	MF H	01/17				C	1241	50	6,30	273,48	x

















														
IGNIS	4WD, NO 2WD	37029/F	MF J	01/17					F	1241	50	6,30	172,78	x
IGNIS	4WD, NO 2WD	37029/C	MF J	01/17					C	1241	50	6,30	274,54	x
IGNIS	4WD, NO 2WD	37029/VM	MF J	01/17					VM	1241	50	6,30	365,70	x
IGNIS	4WD, NO 2WD, HYBRID	37034/F	MF J	01/17					F	1241	50	6,30	206,70	x
IGNIS	4WD, NO 2WD, HYBRID	37034/C	MF J	01/17					C	1241	50	6,30	273,48	x
IGNIS	4WD, NO 2WD, HYBRID	37034/VM	MF J	01/17					VM	1241	50	6,30	376,30	x
JIMNY	2doors 2-4WD, CABRIO	37019	FJ	10/98	09/18				C	1300	75	7,40	332,84	x
JIMNY	2doors 2-4WD, CABRIO	37031/F	GJ, HJ	09/18					F	1590	75	7,40	192,92	x
JIMNY	2doors 2-4WD, CABRIO	37031/C	GJ, HJ	09/18					C	1590	75	7,40	279,84	x
SANTANA - SAMURAI	SHORT 4WD	37010	SJ, SJS	84			x		C	1000	70	6,50	290,44	x
SJ	SHORT 4WD	37003	SJ						C	1000	50		215,18	x
SWIFT III	HATCHBACK 3-5 doors, no rear lower spoiler, no 4X4, no SPORT	37021/F	MZ	04/05	08/10			i	F	1000	60	6,20	160,06	x
SWIFT III	HATCHBACK 3-5 doors, no rear lower spoiler, no 4X4, no SPORT	37021/C	MZ	04/05	08/10			i	C	1000	60	6,20	288,32	x
SWIFT III	4X4 HATCHBACK, no rear lower spoiler	37023/C	EZ	06	08/10				C	1000	60	6,20	307,40	x
SWIFT IV	HATCHBACK 3-5 doors, 4WD, no SPORT bumper	37026/F	FZ-NZ	09/10	05/17	x		i	F	1000	60	6,40	160,06	x
SWIFT IV	HATCHBACK 3-5 doors, 4WD, no SPORT bumper	37026/C	FZ-NZ	09/10	05/17	x		i	C	1000	60	6,40	294,68	x
SWIFT	2-4WD	37030/F	AZ	04/17		x		i	F	1182	70	6,30	192,92	
SWIFT	2-4WD	37030/C	AZ	04/17		x		i	C	1182	70	6,30	274,54	
SWIFT	2-4WD, HYBRID	37035/F	AZ	04/17		x		i	F	1182	70	6,30	227,90	
SWIFT	2-4WD, HYBRID	37035/C	AZ	04/17		x		i	C	1182	70	6,30	280,90	
SWIFT NEO	MPV 3-5 doors 2-4WD	37013	FH	00	03			v	C	800	50	5,80	288,32	x
SWIFT SPORT	HATCHBACK 3 doors, double exhaust pipe	37024/C	MZ	05	10				C	1000	60	6,30	324,36	x
SX4	MPV 5 doors 2-4WD	13145/F	EY, FY, GY	03/06		x		i	F	1200	75	7,80	208,82	x
SX4	MPV 5 doors 2-4WD	13145/C	EY, FY, GY	03/06		x		i	C	1200	75	7,80	278,78	x
SX4	MPV 5 doors 2-4WD	13145/VM	EY, FY, GY	03/06		x		i	VM	1200	75	7,80	354,04	x
SX4 S-CROSS	MPV	37027/F	JY	13	12/21	x		i	F	1840	75	9,00	220,48	x
SX4 S-CROSS	MPV	37027/C	JY	13	12/21	x		i	C	1840	75	9,00	294,68	x
SX4 S-CROSS	MPV	37027/VM	JY	13	12/21	x		i	VM	1840	75	9,00	367,82	x
SX4 S-CROSS	MPV	37027/F	JY	01/22		x		i	F	1840	75	9,00	220,48	x
SX4 S-CROSS	MPV	37027/C	JY	01/22		x		i	C	1840	75	9,00	294,68	x
SX4 S-CROSS	MPV	37027/VM	JY	01/22		x		i	VM	1840	75	9,00	367,82	x
SX4 S-CROSS	HYBRID	37032/F	JY	13	12/21	x		i	F	1840	75	9,00	233,20	x
SX4 S-CROSS	HYBRID	37032/C	JY	13	12/21	x		i	C	1840	75	9,00	312,70	x
SX4 S-CROSS	HYBRID	37032/VM	JY	13	12/21	x		i	VM	1840	75	9,00	402,80	x
SX4 S-CROSS	HYBRID	37032/F	JY	01/22		x		i	F	1840	75	9,00	233,20	x
SX4 S-CROSS	HYBRID	37032/C	JY	01/22		x		i	C	1840	75	9,00	312,70	x
SX4 S-CROSS	HYBRID	37032/VM	JY	01/22		x		i	VM	1840	75	9,00	402,80	x
VITARA	2-4WD	37027/F	LY	04/15		x		i	F	1840	75	9,00	220,48	x
VITARA	2-4WD	37027/C	LY	04/15		x		i	C	1840	75	9,00	294,68	x
VITARA	2-4WD	37027/VM	LY	04/15		x		i	VM	1840	75	9,00	367,82	x
VITARA	HYBRID	37032/F	LY	04/15		x		i	F	1840	75	9,00	233,20	x
VITARA	HYBRID	37032/C	LY	04/15		x		i	C	1840	75	9,00	312,70	x
VITARA	HYBRID	37032/VM	LY	04/15		x		i	VM	1840	75	9,00	402,80	x















														
VITARA	3 doors, SANTANA PS300 4WD, no 2.0 - 16V Petrol, no 2.0 TDI	37025/F5	ETA, ETV, ETJ, SAV	08/88					F	1450	75	8,30	184,44	x
VITARA	3 doors, SANTANA PS300 4WD, no 2.0 - 16V Petrol, no 2.0 TDI	37025/C5	ETA, ETV, ETJ, SAV	08/88					C	1450	75	8,30	219,42	x
VITARA	5 doors, SANTANA PS350 4WD, no 2.0 - 16V Petrol, no 2.0 TDI	37025/F5	ETD, ETW, SAW	91	03/15				F	1450	75	8,30	184,44	x
VITARA	5 doors, SANTANA PS350 4WD, no 2.0 - 16V Petrol, no 2.0 TDI	37025/C5	ETD, ETW, SAW	91	03/15				C	1450	75	8,30	219,42	x
WAGON R+	4 seats MPV, check D value	37012	MM	01/00	02		v		C	650	30	5,40	314,82	x
WAGON R+	5 seats MPV	37016	MM	02	02/08				C	800	35	5,60	314,82	x
TATA														
SAFARI	2nd SERIES 2-4WD	38102	SAF	04			v		C	2000	90	12,50	293,62	x
VAN	PICK-UP JUST 1st SERIES Check D value	38101	207	97	02	x	v		C	1500	75	10,00	321,18	x
VAN	PICK-UP CC. 2.000 distance bushings mm 100	38104/SF	207, SAF	03	07				SF	2000	90	14,70	324,36	x
VAN	PICK-UP CC. 2.000 distance bushings mm 100	38104/G	207, SAF	03	07				GRIFO	2000	90	14,70	495,02	x
VAN	PICK-UP CC. 2.200	38105/SF	207	07					SF	2000	75	14,70	324,36	x
VAN	PICK-UP CC. 2.200	38105/G	207	07					GRIFO	2000	75	14,70	495,02	x
XENON	PICK UP, also for chassis vehicles	38106/SF	464	07					SF	2000	100	14,70	195,04	x
XENON	PICK UP, also for chassis vehicles	38106/G	464	07					GRIFO	2000	100	14,70	495,02	x
TOYOTA														
AVENSIS	Saloon, HATCHBACK 5 doors	39025/F	T25	04/03	12/08	x			F	1500	75	8,70	220,48	x
AVENSIS	Saloon, HATCHBACK 5 doors	39025/C	T25	04/03	12/08	x			C	1500	75	8,70	328,60	x
AVENSIS STATION WAGON	ESTATE	39026/F	T25	04/03	12/08	x			F	1400	75	8,70	220,48	x
AVENSIS STATION WAGON	ESTATE	39026/C	T25	04/03	12/08	x			C	1400	75	8,70	328,60	x
BJ	70 - 71 - 73, LJ 70 - 71 - 73	39006		87					C	1800	105		241,68	x
COROLLA	HATCHBACK 3-5 doors	39023	E12U, E12J	01/02	08/07	x			C	1300	55	8,00	303,16	x
COROLLA VERSO	MPV	39020	E12J1	01/02	03/04				C	1350	55	8,30	340,26	x
COROLLA VERSO	MPV, Restyling	39024/F	R1	03/04	09	x	i		F	1500	65	8,80	196,10	x
COROLLA VERSO	MPV, Restyling	39024	R1	03/04	09	x	i		C	1500	65	8,80	337,08	x
C-HR	SUV	39036/F	AX1T	10/16		x			F	1474	75	8,20	174,90	x
C-HR	SUV	39036/C	AX1T	10/16		x			C	1474	75	8,20	274,54	x
C-HR	SUV	39036/VM	AX1T	10/16		x			VM	1474	75	8,20	339,20	x
C-HR	SUV, hybrid	39042/F	AX1T	10/16		x			F	1474	75	8,20	227,90	x
C-HR	SUV, hybrid	39042/C	AX1T	10/16		x			C	1474	75	8,20	286,20	x
C-HR	SUV, hybrid	39042/VM	AX1T	10/16		x			VM	1474	75	8,20	386,90	x
HI-LUX	4WD, no 2WD	39009		89	01/97				F	1700	105		270,30	x
HI-LUX	4WD, no 2WD	39019	LN, KDN	01/97	09/05				C	2250	90	12,50	220,48	x
HI-LUX	2-4 doors, 4WD, for 2WD buy the original underrun protection bar	39029/F	KUN	10/05	04/16				F	2500	100	14,00	171,72	x
HI-LUX	2-4 doors, 4WD, for 2WD buy the original underrun protection bar	39029/SF	KUN	10/05	04/16				SF	2500	100	14,00	227,90	x
HI-LUX	2-4 doors, 4WD, for 2WD buy the original underrun protection bar	39029/C	KUN	10/05	04/16				C	2500	100	14,00	201,40	x
HI-LUX	2-4 doors, 4WD, for 2WD buy the original underrun protection bar	39029/G	KUN	10/05	04/16				GRIFO	2500	100	14,00	425,06	x















													
HI-LUX	2-4 doors, 2-4WD	39034/SF	AN1P	05/16		x		SF	3863	140	17,20	209,88	x
HI-LUX	2-4 doors, 2-4WD	39034/G	AN1P	05/16		x		GRIFO	3863	140	17,20	360,40	x
HI-LUX	2-4 doors, 2-4WD	39034/SFM	AN1P	05/16		x		SFM	3863	140	17,20	360,40	x
LAND CRUISER 90	4WD 2doors	39015	J9KZJ90, J9KDJ90	08/96	09/02			C	2800	130	13,70	303,16	x
LAND CRUISER 90	4WD 4 doors	39016	J9KZJ95, J9KDJ95	08/96	09/02			C	2800	130	14,00	320,12	x
LAND CRUISER 120/125	WAGON 4WD 3-5 doors	39022/F	J12	03/03	10/08	x	v	F	3500	100	16,50	122,96	x
LAND CRUISER 120/125	WAGON 4WD 3-5 doors	39022	J12	03/03	10/08	x	v	C	3500	100	16,50	204,58	x
LAND CRUISER 150	3-5 doors	39022/F	TOYOTAJ15, J15	11/09		x	v	F	3500	100	16,50	122,96	x
LAND CRUISER 150	3-5 doors	39022	TOYOTAJ15, J15	11/09		x	v	C	3500	100	16,50	204,58	x
PROACE	VAN, no Proace City	07049/F	V	04/16		x		F	2644	120	14,00	181,26	x
PROACE	VAN, no Proace City	07049/C	V	04/16		x		C	2644	120	14,00	254,40	x
PROACE VERSO	MPV, no Proace City	07049/F	V	04/16		x		F	2644	120	14,00	181,26	x
PROACE VERSO	MPV, no Proace City	07049/C	V	04/16		x		C	2644	120	14,00	254,40	x
PROACE CITY VERSO	L1 MPV L=4.400, to open the doors of the version with double rear opening the trailer needs to be detached	07052/F	E	10/19				F	1504	75	8,90	184,44	x
PROACE CITY VERSO	L1 MPV L=4.400, to open the doors of the version with double rear opening the trailer needs to be detached	07052/C	E	10/19				C	1504	75	8,90	237,44	x
PROACE CITY VERSO	L1 MPV L=4.400, to open the doors of the version with double rear opening the trailer needs to be detached	07052/VM	E	10/19				VM	1504	75	8,90	332,84	x
PROACE CITY VERSO	L2 MPV L=4.700, to open the doors of the version with double rear opening the trailer needs to be detached	07053/F	E	10/19				F	1504	75	8,90	184,44	x
PROACE CITY VERSO	L2 MPV L=4.700, to open the doors of the version with double rear opening the trailer needs to be detached	07053/C	E	10/19				C	1504	75	8,90	237,44	x
PROACE CITY VERSO	L2 MPV L=4.700, to open the doors of the version with double rear opening the trailer needs to be detached	07053/VM	E	10/19				VM	1504	75	8,90	332,84	x
RAV4	4WD 3-5 doors	39013/F	SX A1, XA1	95	01/99			F	1500	75	8,50	181,26	x
RAV4	4WD 3-5 doors	39013	SX A1, XA1	95	01/99			C	1500	75	8,50	261,82	x
RAV4 II	4WD 3-5 doors	39021/F	A2, CLA2	05/00	12/05			F	1800	100	9,50	181,26	x
RAV4 II	4WD 3-5 doors	39021	A2, CLA2	05/00	12/05			C	1800	100	9,50	261,82	x
RAV4 III	with or without spare wheel on the rear doorwith or without spare wheel on the rear door, Invisible bumper cut on version Crossover	39030/F	XA3, ALA 30W	01/06	02/13	x		F	2000	80	10,80	171,72	x
RAV4 III	with or without spare wheel on the rear door, Invisible bumper cut on version Crossover	39030/C	XA3, ALA 30W	01/06	02/13	x		C	2000	80	10,80	328,60	x
RAV4 III	with or without spare wheel on the rear door, Invisible bumper cut on version Crossover	39030/VM	XA3, ALA 30W	01/06	02/13	x		VM	2000	80	10,80	416,58	x
RAV4 IV	5 doors 2-4WD, Hybrid	39033/F	XA3, XA4	03/13	12/18	x	v	F	2000	80	11,00	196,10	x
RAV4 IV	5 doors 2-4WD, Hybrid	39033/C	XA3, XA4	03/13	12/18	x	v	C	2000	80	11,00	309,52	x















													
RAV4 IV	5 doors 2-4WD, Hybrid	39033/VM	XA3, XA4	03/13	12/18	x	v	VM	2000	80	11,00	402,80	x
RAV4 V	5 doors 2-4WD	39037/F	XA5	01/19		x	i	F	2234	70	11,00	239,56	x
RAV4 V	5 doors 2-4WD	39037/C	XA5	01/19		x	i	C	2234	70	11,00	332,84	x
RAV4 V	5 doors 2-4WD	39037/VM	XA5	01/19		x	i	VM	2234	70	11,00	355,10	x
RAV4 V	5 doors 2-4WD, HYBRID	39043/F	XA5	01/19		x	i	F	2234	70	11,00	239,56	x
RAV4 V	5 doors 2-4WD, HYBRID	39043/C	XA5	01/19		x	i	C	2234	70	11,00	307,40	x
RAV4 V	5 doors 2-4WD, HYBRID	39043/VM	XA5	01/19		x	i	VM	2234	70	11,00	386,90	x
RUNNER	4WD	39010	LN, VZN	90				C	2000	100		250,16	x
URBAN CRUISER	2WD, only with transversal exhaust, NOT lateral exhaust	39032/2F	XP11	03/09				F	800	50	6,00	184,44	x
URBAN CRUISER	2WD, only with transversal exhaust, NOT lateral exhaust	39032/2C	XP11	03/09				C	800	50	6,00	328,60	x
URBAN CRUISER	2WD, only with transversal exhaust, NOT lateral exhaust	39032/2VM	XP11	03/09				VM	800	50	6,00	397,50	x
URBAN CRUISER	4WD, only with transversal exhaust, NOT lateral exhaust	39032/4F	XP11	03/09				F	800	50	6,00	184,44	x
URBAN CRUISER	4WD, only with transversal exhaust, NOT lateral exhaust	39032/4C	XP11	03/09				C	800	50	6,00	328,60	x
URBAN CRUISER	4WD, only with transversal exhaust, NOT lateral exhaust	39032/4VM	XP11	03/09				VM	800	50	6,00	397,50	x
VERSO	MPV	39031	AR2	01/09				C	1300	55	8,70	296,80	x
YARIS	HATCHBACK 3-5 doors, no TS version	39017	P1	01/99	12/05			C	900	45	5,80	331,78	x
YARIS	HATCHBACK 3-5 doors	39028/F	XP9, XP13	06	07/14		i	F	1050	50	6,70	160,06	x
YARIS	HATCHBACK 3-5 doors	39028/C	XP9, XP13	06	07/14		i	C	1050	50	6,70	258,64	x
YARIS	HATCHBACK 3-5 doors, (Hybrid, check towing capacity)	39038/F	XP9, XP13	08/14	01/20			F	1050	50	6,70	185,50	x
YARIS	HATCHBACK 3-5 doors, (Hybrid, check towing capacity)	39038/C	XP9, XP13	08/14	01/20			C	1050	50	6,70	296,80	x
YARIS	HATCHBACK 3-5 doors	39039/F	XPA1F	02/20		x	i	F	984	50	6,00	222,60	x
YARIS	HATCHBACK 3-5 doors	39039/C	XPA1F	02/20		x	i	C	984	50	6,00	275,60	x
YARIS HYBRID	Hybrid	39040/F	XPA1F	02/20		x	i	F	984	50	6,00	302,10	x
YARIS HYBRID	Hybrid	39040/C	XPA1F	02/20		x	i	C	984	50	6,00	344,50	x
YARIS CROSS	HYBRID, AWD	39041/F	MXP	04/21		x	i	F	981	60	6,20	233,20	x
YARIS CROSS	HYBRID, AWD	39041/C	MXP	04/21		x	i	C	981	60	6,20	307,40	x
YARIS CROSS	HYBRID, AWD	39041/VM	MXP	04/21		x	i	VM	981	60	6,20	381,60	x
YARIS VERSO	MPV, no TURBO DIESEL	39018	P2	01/99	06			C	900	45	6,00	331,78	x
VOLKSWAGEN													
AMAROK	With step bumper, check D value	43059/F	2H	01/11				F	2800	120	15,00	86,92	x
AMAROK	With step bumper, check D value	43059/SF	2H	01/11				SF	2800	120	15,00	111,30	x
AMAROK	With step bumper, check D value	43059/C	2H	01/11				C	2800	120	15,00	196,10	x
AMAROK	With step bumper, check D value	43059/G	2H	01/11				GRIFO	2800	120	15,00	444,14	x
BORA	Saloon, no 4x4	43042/F	1J SC, 1J ST	10/98	3	x	v	F	1500	75	8,50	151,58	x
BORA	Saloon, no 4x4	43042	1J SC, 1J ST	10/98	03	x	v	C	1500	75	8,50	227,90	x
BORA VARIANT	ESTATE no 4X4	43045	1JSE, 1JBV	01/99	09	x	v	C	1500	75	9,00	236,38	x
CADDY III	VAN, Ecofuel, 4 motion, also with parking sensors	43062/F	2K	03/04	05/15	x		F	1588	80	9,40	220,48	x
CADDY III	VAN, Ecofuel, 4 motion, also with parking sensors	43062/C	2K	03/04	05/15	x		C	1588	80	9,40	328,60	x

													
CADDY III	VAN, Ecofuel, 4 motion, also with parking sensors	43062/VM	2K	03/04	05/15	x		VM	1588	80	9,40	380,54	x
CADDY III MAXI	VAN, Ecofuel, 4 motion, also with parking sensors	43062/F	2K	03/04	05/15	x		F	1588	80	9,40	220,48	x
CADDY III MAXI	VAN, Ecofuel, 4 motion, also with parking sensors	43062/C	2K	03/04	05/15	x		C	1588	80	9,40	328,60	x
CADDY III MAXI	VAN, Ecofuel, 4 motion, also with parking sensors	43062/VM	2K	03/04	05/15	x		VM	1588	80	9,40	380,54	x
CADDY IV	VAN, TGI, 4 motion, also with parking sensors	43062/F	2K	06/15	08/20	x		F	1588	80	9,40	220,48	x
CADDY IV	VAN, TGI, 4 motion, also with parking sensors	43062/C	2K	06/15	08/20	x		C	1588	80	9,40	328,60	x
CADDY IV	VAN, TGI, 4 motion, also with parking sensors	43062/VM	2K	06/15	08/20	x		VM	1588	80	9,40	380,54	x
CADDY IV MAXI	VAN, TGI, 4 motion, also with parking sensors	43062/F	2K	06/15	08/20	x		F	1588	80	9,40	220,48	x
CADDY IV MAXI	VAN, TGI, 4 motion, also with parking sensors	43062/C	2K	06/15	08/20	x		C	1588	80	9,40	328,60	x
CADDY IV MAXI	VAN, TGI, 4 motion, also with parking sensors	43062/VM	2K	06/15	08/20	x		VM	1588	80	9,40	380,54	x
CADDY V	VAN, also with parking sensors	43069/F	SK	09/20		x		F	1897	100	10,00	233,20	x
CADDY V	VAN, also with parking sensors	43069/C	SK	09/20		x		C	1897	100	10,00	296,80	x
CADDY V	VAN, also with parking sensors	43069/VM	SK	09/20		x		VM	1897	100	10,00	397,50	x
CRAFTER	PICK UP, with platform, no twin rear wheel, maximum weight 3900 kg	23043/SF	2F, 2EK	06/06	12/14			SF	2800	120	16,00	251,22	x
CRAFTER	VAN, PICK UP, with platform, no twin rear wheel, maximum weight 3900 kg	23043/G	2F, 2EK	06/06	12/14		v	GRIFO	2800	120	16,00	463,22	x
CRAFTER 30-50	VAN, with platform, no twin rear wheel, maximum weight 3900 kg	23043/SF	2F, 2EK	06/06	12/14		v	SF	2800	120	16,00	251,22	x
FOX	HATCHBACK, check towing capacity	43057/C	5Z	05		x	v	C	800	50	6,00	328,60	x
GOLF III	HATCHBACK 3-5 doors	43036	1E, 1EAB, 1H, 1HSC	01/92	01/97	x	v	C	1300	75		227,90	x
GOLF III CABRIOLET	CABRIO	43036	1E, 1EAB, 1H, 1HSC	11/93	02/98	x	v	C	1300	75		227,90	x
GOLF IV	HATCHBACK 3-5 doors, no 4X4	43042/F	1J SC, 1J ST	01/97	3	x	v	F	1500	75	8,50	151,58	x
GOLF IV	HATCHBACK 3-5 doors, no 4X4	43042	1J SC, 1J ST	01/97	03	x	v	C	1500	75	8,50	227,90	x
GOLF IV VARIANT	ESTATE, no 4x4	43045	1JSE, 1JBV	03/99	05/06	x	v	C	1500	75	9,00	236,38	x
GOLF V-VI	HATCHBACK 3-5 doors 4MOTION 4x4, no GTI	02033/F	1KAB, 1KAC, 1K	10/03	10/12	x	v	F	2190	80	10,35	147,34	x
GOLF V-VI	HATCHBACK 3-5 doors 4MOTION 4x4, no GTI	02033/C	1KAB, 1KAC, 1K	10/03	10/12	x	v	C	2190	80	10,35	270,30	x
GOLF V-VI	HATCHBACK 3-5 doors 4MOTION 4x4, no GTI, invisible bumper cut with original spoiler	02033/VM	1KAB, 1KAC, 1K	10/03	10/12	x	v	VM	2190	80	10,35	338,14	x
GOLF V-VI PLUS	MPV	02033/F	1KP	03/05	05/14	x	v	F	2190	80	10,35	147,34	x
GOLF V-VI PLUS	MPV	02033/C	1KP	03/05	05/14	x	v	C	2190	80	10,35	270,30	x
GOLF V-VI PLUS	MPV, invisible bumper cut with original spoiler	02033/VM	1KP	03/05	05/14	x	v	VM	2190	80	10,35	338,14	x
GOLF V-VI VARIANT	ESTATE, 4MOTION 4X4	43055/F	1KMAC	06/07	12/13	x	v	F	1500	75	9,30	160,06	x
GOLF V-VI VARIANT	ESTATE, 4MOTION 4X4	43055/C	1KMAC	06/07	12/13	x	v	C	1500	75	9,30	246,98	x
GOLF V-VI VARIANT	ESTATE, 4MOTION 4X4	43055/VM	1KMAC	06/07	12/13	x	v	VM	1500	75	9,30	338,14	x

															
GOLF VII	HATCHBACK 3-5 doors 4MOTION 4x4, TGI, SPORTSVAN, no GTI	02033/F	AU	11/12		x	v	F	2190	80	10,35	147,34		x	
GOLF VII	HATCHBACK 3-5 doors 4MOTION 4x4, TGI, SPORTSVAN, no GTI	02033/C	AU	11/12		x	v	C	2190	80	10,35	270,30		x	
GOLF VII	HATCHBACK 3-5 doors 4MOTION 4x4, TGI, SPORTSVAN, no GTI	02033/VM	AU	11/12		x	v	VM	2190	80	10,35	338,14		x	
GOLF VII VARIANT	ESTATE, TGI, no Sportsvan	43060/F	AUV	13		x		F	2245	100	10,36	171,72		x	
GOLF VII VARIANT	ESTATE, TGI, no Sportsvan	43060/C	AUV	13		x		C	2245	100	10,36	270,30		x	
GOLF VII VARIANT	ESTATE, TGI, no Sportsvan	43060/VM	AUV	13		x		VM	2245	100	10,36	323,30		x	
GOLF VIII	HATCHBACK 5 doors, TGI, no Hybrid	43070/F	CD	07/19		x		F	2575	100	12,20	159,00		x	
GOLF VIII	HATCHBACK 5 doors, TGI, no Hybrid	43070/C	CD	07/19		x		C	2575	100	12,20	265,00		x	
GOLF VIII	HATCHBACK 5 doors, TGI, no Hybrid	43070/VM	CD	07/19		x		VM	2575	100	12,20	371,00		x	
JETTA	Saloon	43055/F	1KMAA	01/05	10	x	v	F	1500	75	9,30	160,06		x	
JETTA	Saloon	43055/C	1KMAA	01/05	10	x	v	C	1500	75	9,30	246,98		x	
JETTA	Saloon	43055/VM	1KMAA	01/05	10	x	v	VM	1500	75	9,30	338,14		x	
LUPO	HATCHBACK 3 doors	43044	6X	10/98		x	v	C	800	50	5,50	299,98	x		
PASSAT	Saloon, 4X4	43039	35I	01/93	01/96	x	v	C	1500	75		213,06		x	
PASSAT	Saloon, no 4X4	43041/F	3B	01/96	10/00	x	i	F	1700	85	9,66	151,58		x	
PASSAT	Saloon, no 4X4	43041	3B	01/96	10/00	x	i	C	1700	85	9,66	189,74		x	
PASSAT	Saloon, no 4X4	43047/F	3BG X01	11/00	02/05	x		F	1800	75	10,50	186,56		x	
PASSAT	Saloon, no 4X4	43047/C	3BG X01	11/00	02/05	x		C	1800	75	10,50	255,46		x	
PASSAT	Saloon, 4MOTION	43052/F	3C	03/05	09/10	x	v	F	2000	85	10,50	171,72		x	
PASSAT	Saloon, 4MOTION	43052/C	3C	03/05	09/10	x	v	C	2000	85	10,50	238,50		x	
PASSAT	Saloon, 4MOTION	43052/VM	3C	03/05	09/10	x	v	VM	2000	85	10,50	338,14		x	
PASSAT	Saloon B7, ECOFUEL	43063/F	3C	10/10	10/14	x	i	F	2652	90	12,00	196,10		x	
PASSAT	Saloon B7, ECOFUEL	43063/C	3C	10/10	10/14	x	i	C	2652	90	12,00	288,32		x	
PASSAT	Saloon B7, ECOFUEL	43063/VM	3C	10/10	10/14	x	i	VM	2652	90	12,00	380,54		x	
PASSAT	Saloon B8	43063/F	3C	11/14		x	i	F	2652	90	12,00	196,10		x	
PASSAT	Saloon B8	43063/C	3C	11/14		x	i	C	2652	90	12,00	288,32		x	
PASSAT	Saloon B8	43063/VM	3C	11/14		x	i	VM	2652	90	12,00	380,54		x	
PASSAT CC	COUPE'	43063/F	3C	04/08	12/12	x	i	F	2652	90	12,00	196,10		x	
PASSAT CC	COUPE'	43063/C	3C	04/08	12/12	x	i	C	2652	90	12,00	288,32		x	
PASSAT CC	COUPE'	43063/VM	3C	04/08	12/12	x	i	VM	2652	90	12,00	380,54		x	
PASSAT VARIANT	ESTATE, 4X4	43039	35I	01/93	01/96	x	v	C	1500	75		213,06		x	
PASSAT VARIANT	VARIANT, no 4X4	43041	3B	01/97	10/00	x	i	C	1700	85	9,66	189,74		x	
PASSAT VARIANT	VARIANT, no 4X4	43041/F	3B	01/97	10/00	x	i	F	1700	85	9,66	151,58		x	
PASSAT VARIANT	ESTATE no 4X4	43047/F	3BG X01	12/00	08/05	x		F	1800	75	10,50	186,56		x	
PASSAT VARIANT	ESTATE no 4X4	43047/C	3BG X01	12/00	08/05	x		C	1800	75	10,50	255,46		x	
PASSAT VARIANT	ESTATE, 4MOTION	43052/F	3C	08/05	09/10	x	v	F	2000	85	10,50	171,72		x	
PASSAT VARIANT	ESTATE, 4MOTION	43052/C	3C	08/05	09/10	x	v	C	2000	85	10,50	238,50		x	
PASSAT VARIANT	ESTATE, 4MOTION	43052/VM	3C	08/05	09/10	x	v	VM	2000	85	10,50	338,14		x	
PASSAT VARIANT	ESTATE B7, ECOFUEL	43063/F	3C	10/10	10/14	x	i	F	2652	90	12,00	196,10		x	
PASSAT VARIANT	ESTATE B7, ECOFUEL	43063/C	3C	10/10	10/14	x	i	C	2652	90	12,00	288,32		x	
PASSAT VARIANT	ESTATE B7, ECOFUEL	43063/VM	3C	10/10	10/14	x	i	VM	2652	90	12,00	380,54		x	
PASSAT VARIANT	ESTATE B8, Restyling '19, R-Line	43063/F	3C	11/14		x	i	F	2652	90	12,00	196,10		x	
PASSAT VARIANT	ESTATE B8, Restyling '19, R-Line	43063/C	3C	11/14		x	i	C	2652	90	12,00	288,32		x	
PASSAT VARIANT	ESTATE B8, Restyling '19, R-Line	43063/VM	3C	11/14		x	i	VM	2652	90	12,00	380,54		x	
POLO III	HATCHBACK 3-5 doors Restyling	43046	6NSC	01/00	12/01	x	v	C	800	50	5,70	275,60	x		

													
POLO IV	HATCHBACK, restyling, no FUN, no CROSS	43048	9N SC, 9N AD, 9N AB	01/02	06/09	x	v	C	1200	50	7,60	215,18	x
POLO V	HATCHBACK 3-5 doors, also Restyling '14, also CROSS	43058/F	6R AB	07/09	10/17	x	v	F	1200	50	7,50	171,72	x
POLO V	HATCHBACK 3-5 doors, also Restyling '14, also CROSS	43058/C	6R AB	07/09	10/17	x	v	C	1200	50	7,50	216,24	x
POLO V	HATCHBACK 3-5 doors, also Restyling '14, also CROSS	43058/VM	6R AB	07/09	10/17	x	v	VM	1200	50	7,50	313,76	x
POLO VI	HATCHBACK 3-5 doors, AdBlue, No R-Line	33024/F	AW	11/17	05/21	x		F	1457	75	7,80	192,92	x
POLO VI	HATCHBACK 3-5 doors, AdBlue, No R-Line	33024/C	AW	11/17	05/21	x	i	C	1457	75	7,80	303,16	x
POLO VI	HATCHBACK 3-5 doors, AdBlue, No R-Line	33024/VM	AW	11/17	05/21	x	i	VM	1457	75	7,80	355,10	x
POLO VARIANT	ESTATE	43043	6KVSE	01/97		x	v	C	1000	50	7,00	329,66	x
SHARAN	MPV, 4X4 1st SERIES	14063/1F	7M	06/95	00	x	v	F	2085	85	11,66	221,54	x
SHARAN	MPV, 4X4 1st SERIES	14063/1	7M	06/95	00	x	v	C	2085	85	11,66	262,88	x
SHARAN	MPV, 4X4 2nd SERIES	14063/2F	7M	00	08/10	x		F	2085	85	11,66	221,54	x
SHARAN	MPV, 4X4 2nd SERIES	14063/2	7M	00	08/10	x		C	2085	85	11,66	262,88	x
SHARAN	MPV, invisible bumper cut if it has the original flap 7NO 807 521A	33022/F	7N	09/10		x	v	F	2200	100	12,00	171,72	x
SHARAN	MPV, invisible bumper cut if it has the original flap 7NO 807 521A	33022/C	7N	09/10		x	v	C	2200	100	12,00	256,52	x
SHARAN	MPV, invisible bumper cut if it has the original flap 7NO 807 521A	33022/VM	7N	09/10		x	v	VM	2200	100	12,00	338,14	x
T-CROSS	2WD	43068/F	C1	01/19		x	i	F	1357	55	7,50	151,58	x
T-CROSS	2WD	43068/C	C1	01/19		x	i	C	1357	55	7,50	262,88	x
T-CROSS	2WD	43068/VM	C1	01/19		x	i	VM	1357	55	7,50	358,28	x
T-ROC	2-4WD, R-LINE	33023/F	A1	07/17		x		F	2575	100	12,20	163,24	x
T-ROC	2-4WD, R-LINE	33023/C	A1	07/17		x		C	2575	100	12,20	262,88	x
T-ROC	2-4WD, R-LINE	33023/VM	A1	07/17		x		VM	2575	100	12,20	318,00	x
TIGUAN	2-4WD, check D value	33023/F	5N	10/07	01/16	x	i	F	2575	100	12,20	163,24	x
TIGUAN	2-4WD, check D value	33023/C	5N	10/07	01/16	x	i	C	2575	100	12,20	262,88	x
TIGUAN	2-4WD, check D value	33023/VM	5N	10/07	01/16	x	i	VM	2575	100	12,20	318,00	x
TIGUAN	2-4WD, AdBlue, R-LINE, ALL-SPACE, check D value	33023/F	5N	02/16		x		F	2575	100	12,20	163,24	x
TIGUAN	2-4WD, AdBlue, R-LINE, ALL-SPACE, check D value	33023/C	5N	02/16		x		C	2575	100	12,20	262,88	x
TIGUAN	2-4WD, AdBlue, R-LINE, ALL-SPACE, check D value	33023/VM	5N	02/16		x		VM	2575	100	12,20	318,00	x
TOURAN	MPV, ECO-FUEL, Restyling '10	43064/F	1T	01/03	11/15	x	i	F	2050	75	10,60	160,06	x
TOURAN	MPV, ECO-FUEL, Restyling '10	43064/C	1T	01/03	11/15	x	i	C	2050	75	10,60	284,08	x
TOURAN	MPV, ECO-FUEL, Restyling '10	43064/VM	1T	01/03	11/15	x	i	VM	2050	75	10,60	375,24	x
TOURAN	MPV	43065/F	1T	11/15		x		F	2179	80	11,00	160,06	x
TOURAN	MPV	43065/C	1T	11/15		x		C	2179	80	11,00	284,08	x
TOURAN	MPV	43065/VM	1T	11/15		x		VM	2179	80	11,00	375,24	x
TRANSPORTER T4	VAN	43033	70X0, 70X1	09/90	98	x		C	2000	100		243,80	x
TRANSPORTER T5	VAN, MULTI VAN with or without parking sensors	43061/F	7HC, 7HM, 7HMA, 7HKX0, 7J0	04/03	07/15	x		F	2575	100	14,00	184,44	x

														
TRANSPORTER T5	VAN, MULTI VAN with or without parking sensors	43061/C	7HC, 7HM, 7HMA, 7HKX0, 7J0	04/03	07/15	x		C	2575	100	14,00	288,32		x
TRANSPORTER T5	VAN, MULTI VAN with or without parking sensors	43061/VM	7HC, 7HM, 7HMA, 7HKX0, 7J0	04/03	07/15	x		VM	2575	100	14,00	360,40		x
TRANSPORTER T6	VAN, MULTI VAN with or without parking sensors	43061/F	7HC, 7HM, 7HMA, 7HKX0, 7J0	08/15		x		F	2575	100	14,00	184,44		x
TRANSPORTER T6	VAN, MULTI VAN with or without parking sensors	43061/C	7HC, 7HM, 7HMA, 7HKX0, 7J0	08/15		x		C	2575	100	14,00	288,32		x
TRANSPORTER T6	VAN, MULTI VAN with or without parking sensors	43061/VM	7HC, 7HM, 7HMA, 7HKX0, 7J0	08/15		x		VM	2575	100	14,00	360,40		x
VOLVO														
944 - 964 - S90	Saloon	44010		91				C	1600	75		239,56	x	
945 - 965 - POLAR	Saloon, ESTATE	44011		91	96			C	1600	75		239,56	x	
S40	Saloon, Restyling	44012	VW, VS	01/96	05/04	x	i	C	1400	75	8,30	266,06	x	
S40	Saloon	44014/F2	M MS	05/04		x	i	F	1500	75	9,20	208,82		x
S40	Saloon	44014/C2	M MS	05/04		x	i	C	1500	75	9,20	293,62		x
S40	Saloon	44014/VM2	M MS	05/04		x	i	VM	1500	75	9,20	339,20		x
S60	Saloon	44022/F	F FS	10/10	12/18	x	v	F	2132	90	11,30	174,90		x
S60	Saloon	44022/C	F FS	10/10	12/18	x	v	C	2132	90	11,30	286,20		x
S60	Saloon	44022/VM	F FS	10/10	12/18	x	v	VM	2132	90	11,30	355,10		x
V40	ESTATE, Restyling	44012	VW, VS	01/96	05/04	x	i	C	1400	75	8,30	266,06	x	
V40	ESTATE, Cross Country	44015/F	M MV, M MZ	06/12		x	i	F	1400	75	9,80	208,82		x
V40	ESTATE, Cross Country	44015/C	M MV, M MZ	06/12		x	i	C	1400	75	9,80	266,06		x
V40	ESTATE, Cross Country	44015/VM	M MV, M MZ	06/12		x	i	VM	1400	75	9,80	376,30		x
V50	ESTATE	44014/F1	M MW	05/04		x	i	F	1500	75	9,20	202,46		x
V50	ESTATE	44014/C1	M MW	05/04		x	i	C	1500	75	9,20	297,86		x
V50	ESTATE	44014/VM1	M MW	05/04		x	i	VM	1500	75	9,20	344,50		x
V60	ESTATE, R-Design, no Cross Country	44022/F	F FW	12/10	02/18	x	v	F	2132	90	11,30	174,90		x
V60	ESTATE, R-Design, no Cross Country	44022/C	F FW	12/10	02/18	x	v	C	2132	90	11,30	286,20		x
V60	ESTATE, R-Design, no Cross Country	44022/VM	F FW	12/10	02/18	x	v	VM	2132	90	11,30	355,10		x
V70	ESTATE, no 4x4	44013/C1	S SW	01/00	08/07	x	v	C	2000	80	10,60	248,04		x
V70	ESTATE, no 4x4	44013/F1	S SW	01/00	08/07	x	v	F	2000	80	10,60	204,58		x
V70	ESTATE	44021/F	B BZ	09/07		x	v	F	2132	90	11,30	174,90		x
V70	ESTATE	44021/C	B BZ	09/07		x	v	C	2132	90	11,30	286,20		x
V70	ESTATE	44021/VM	B BZ	09/07		x	v	VM	2132	90	11,30	355,10		x
XC60	2-4WD	44021/F	D DZ	11/08	09/17	x	v	F	2132	90	11,30	174,90		x
XC60	2-4WD	44021/C	D DZ	11/08	09/17	x	v	C	2132	90	11,30	286,20		x
XC60	2-4WD	44021/VM	D DZ	11/08	09/17	x	v	VM	2132	90	11,30	355,10		x
XC60	2-4WD	44020/F	U UZ	11/17		x	v	F	2745	140	13,60	180,20		x
XC60	2-4WD	44020/C	U UZ	11/17		x	v	C	2745	140	13,60	288,32		x
XC60	2-4WD	44020/VM	U UZ	11/17		x	v	VM	2745	140	13,60	386,90		x
XC40	Standard, Momentum, R-Design, Inscription	44023/F	X XZ	10/17		x	i	F	2447	120	11,50	217,30		x
XC40	Standard, Momentum, R-Design, Inscription	44023/C	X XZ	10/17		x	i	C	2447	120	11,50	307,40		x

														
XC40	Standard, Momentum, R-Design, Inscription	44023/VM	X XZ	10/17		x	i	VM	2447	120	11,50	397,50		x
XC70	ESTATE	44013/C2	S SZ	01	08/07	x	v	C	2000	80	10,60	248,04		x
XC70	ESTATE	44021/F	B BW, B BZ	09/07		x	v	F	2132	90	11,30	174,90		x
XC70	ESTATE	44021/C	B BW, B BZ	09/07		x	v	C	2132	90	11,30	286,20		x
XC70	ESTATE	44021/VM	B BW, B BZ	09/07		x	v	VM	2132	90	11,30	355,10		x
XC90	2-4WD	44019/F	C CM, C CZ, C CT	01/03	05/15		i	F	2418	100	12,20	180,20		x
XC90	2-4WD	44019/C	C CM, C CZ, C CT	01/03	05/15		i	C	2418	100	12,20	288,32		x
XC90	2-4WD	44019/VM	C CM, C CZ, C CT	01/03	05/15		v	VM	2418	100	12,20	386,90		x
XC90	4WD, R-Design	44020/F	YV1L, L LC, L LF	06/15		x	v	F	2745	140	13,60	180,20		x
XC90	4WD, R-Design	44020/C	YV1L, L LC, L LF	06/15		x	v	C	2745	140	13,60	288,32		x
XC90	4WD, R-Design	44020/VM	YV1L, L LC, L LF	06/15		x	v	VM	2745	140	13,60	386,90		x

SPARE PARTS AND ACCESSORIES







FOR TOWBARS







	DESCRIPTION	PRODUCT CODE
	Iso 50 m22 treaded ball with nut	GA.SF.FIL
	Iso 50 m18 treaded ball with nut	GA.SF.FIL.18
	Fixed flanged ball with two holes	GA.RI.0001/A
	Fixed swan neck ball	GA.RI.0002
	Manually detachable ball	GA.RI.0003.1
	Towbar with fixed Grifo hook (specify hole- see page 75)	GA.GRIFO ...
	Bent socket holder	089900110200350000
	Straight socket holder	089900110200250000
	Nozzle for manually detachable ball (specify towbar code)	GA.BL.C ...
	Angle bracket for flanged ball (specify towbar code)	955.300

	Safety lock with key for new manually detachable ball	GA.RI.00066
	Lever for new manually detachable ball	089900120200100000
	Safety lock for manually detachable ball	LC01
	Key for vertical detachable ball that disappears completely (specify the key code)	955.999
	C device with ball (specify towbar code)	GA.RI.0021
	VM device with ball	GA.RI.0024
	SF(M) device with ball (specify towbar code)	GA.MIX
	Ball cover	GA.RI.0013
	Cap for C device	GA.RI.0014C
	Cap for VM device	GV-14
	Ball's bag	SACCH.04
	VM handle	01
	Duplicate of the towbar's document	

WIRING KITS AND ELECTRICAL DEVICES

FOR TOWBARS

	DESCRIZIONE	CODICE PRODOTTO
	C7 Kit - 7 pin universal wiring kit without junction box	955.000
	C7+C Kit - 7 pin wiring kit with universal junction box	955.402
	C7+CPDC Kit - 7 pin wiring kit with universal junction box and automatic cut off of the PDC (Park Distance Control) ⚠ WARNING: before disconnecting the PDC sensor, it is advisable to consult with your installer. Some vehicles the operation can cause errors and it is advisable to disconnect it manually from the on-board computer.	955.400
	C Kit - 13 pin universal wiring kit without junction box	955.655
	C+C Kit - 13 pin wiring kit with universal junction box	955.403
	C+CPDC Kit - 13 pin wiring kit with universal junction box without automatic cut off of the PDC (Park Distance Control) ⚠ WARNING: before disconnecting the PDC sensor, it is advisable to consult with your installer. Some vehicles the operation can cause errors and it is advisable to disconnect it manually from the on-board computer.	955.401
	Kit LIN - Adapter for cars that implement the LIN protocol <i>Check compatibility</i>	955.705
	Kit C 7 SMART - 7-pin universal control unit programmable with tester functions via app	955.701
	Kit C 13 SMART - 13-pin universal control unit programmable with tester functions via app	955.702
	Kit C 7 VAN - 7-pin CAN universal control unit programmable for campers and vans via app <i>Check compatibility</i>	955.703
	Kit C 13 VAN - Universal CAN control unit with 13 pins programmable for campers and vans via app <i>Check compatibility</i>	955.704

	<p>7SPEC Kit - 7 pin specific wiring kit with junction box <i>(verify availability)</i></p>	<p>955.100</p>
	<p>Kit 13 SPEC - cablaggio elettrico a 13 poli con centralina elettronica specifico per l'autovettura (verificare disponibilità)</p>	<p>955.101</p>
	<p>7 pin socket</p>	<p>PRESA.0001</p>
	<p>13 pin socket</p>	<p>PRESA.0003</p>
	<p>13-7 pin adapter</p>	<p>ADAT.0004</p>
	<p>7-13 pin adapter</p>	<p>ADAT.0005</p>

GENERAL TERMS

OF SALE

1- Effectiveness of the General Terms

The General Terms, except for possible derogations specifically agreed in writing, discipline all the current and future terms of sale between the parties.

Statements of agents, procurers, distributors or other mediators do not commit Umbra Rimorchi in any way, unless they result from a relevant written document signed by the pro tempore legal representative of Umbra Rimorchi.

2- Delivery

Ex-Works Umbra Rimorchi plant located in Perugia.

Different terms of delivery will have to be agreed in writing with Umbra Rimorchi. In any case the goods always travel at the buyer's risk.

3- Prices and taxes

Prices shown in this price list are to be considered exclusive of VAT.

Unless otherwise agreed, the Umbra Rimorchi price list in force will be applied at the date of conclusion of the contract.

4- Terms and conditions

Unless otherwise agreed in writing, payment of the prices and of all other amounts due for any reason by the Customer to Umbra Rimorchi will have to be made to the seat of the firm or if necessary in an other place previously indicated in writing by Umbra Rimorchi.

The Customer will have to make the payments exactly in compliance with the terms and conditions agreed with Umbra Rimorchi. The non-compliance with the terms and conditions, releases Umbra Rimorchi from the fulfilment of the delivery obligations, in the case that the delivery has already taken place, the non fulfilment of any obligation by the Customer subsequent to the delivery, will involve the loss for the Customer of any benefit agreed in his favour and will therefore give Umbra Rimorchi the right to demand payment of the whole residual amount, in addition to the interest, starting from the expiry date to the actual payment at the nominal 8% annual interest rate, or if higher, at the rate of the Legislative Decree n° 231/2000 art.4 (where applicable).

Where the delay in payment exceeds 30 days from the expiry date, Umbra Rimorchi is in any case in the right to rescind the contract, except for damage compensation.

5- Complains and products restitutions

Possible complaints with regards to obvious faults (such as packing, quantity, colour, number and exterior characteristics) will have to be notified to Umbra Rimorchi by registered letter within 8 days of the delivery date of the products or forfeit the right to reclaim. Possible complaints with regards to concealed faults (flaws that cannot be identified through scrupulous inspection at the moment of delivery) will have to be notified to Umbra Rimorchi by registered letter within 8 days of discovering the flaw and anyway not more than 12 months from delivery or forfeit the right to reclaim.

It is understood that possible complaints or claims do not give the Customer the right to suspend or delay payment of the products in dispute. The products cannot be returned if the restitution hasn't been previously authorized in writing by Umbra Rimorchi.

The unauthorized restitution will not in any way effect the rescission of the sales contract and so Umbra Rimorchi will have the right to demand the due payment.

The faulty products will have to be delivered directly to Umbra Rimorchi or to an authorized Umbra Rimorchi Customer Service at the Customer's expense. Any complaints or delivery made to agents, brokers, distributors and other mediators will be of no effect in accordance with the present paragraph.

6- Flaw guarantee

Umbra Rimorchi guarantees the conformity of the products supplied as explicitly agreed. The guarantee for flaws is limited to defects in design, material or manufacture for which Umbra Rimorchi can be proven to be responsible. The Customer loses the right to the guarantee if:

- he doesn't use the product correctly;
- he assembles or disassembles it without scrupulously following the fitting instructions and using non-original parts;
- he hasn't taken care of the maintenance and preservation of the products in accordance with the indications of the fitting instructions;
- he has modified or tried to fix the product without the permission of Umbra Rimorchi.

Umbra Rimorchi undertakes to rectify the above mentioned flaws, lack of quality or defects in conformity of the products for which Umbra Rimorchi can be proven to be directly responsible which may occur within twenty-four months of delivery, if the defects are brought to their attention immediately in accordance with art.5 and only in the event that the presence of the reported flaws are confirmed by an Umbra Rimorchi authorized Customer Service Centre or directly by Umbra Rimorchi.

Umbra Rimorchi can choose whether to repair or substitute the faulty products, except in the event of fraud or gross negligence by Umbra Rimorchi the compensation for damage for the Customer cannot however be more than the part of the amount indicated in the invoice which the Customer has already paid.

The guarantee referred to in this paragraph absorbs and substitutes the legal rules and regulations of the guarantee for defects and excludes any other liability of Umbra Rimorchi originating from the products supplied; therefore, the Customer can not boast claims that do not conform to the conventional rules of the guarantee, such as, for example, claims for damage, reduction of price or rescission of the contract. Elapsed the warranty period no claim can be made against Umbra Rimorchi, in any case.

7- Documents and testing and registration fees

The documents for the testing of tow bars and for the registration or coupling of trailers, are included in the price list; the cost of its papers is to be borne exclusively by the Customer.

8- Discipline of the guarantee in the event of applicability of the Consumer Code

Provided that there are the subjective and objective conditions for the application of the Consumer Code, the provisions of Title II - Liability for defective products - and Title III - Legal guarantee of conformity and commercial guarantees for consumer goods will be applied to the sales made by Umbra Rimorchi - Legislative Decree 206/2005.

9- Jurisdiction

For any dispute concerning rights and obligations arising from this contract the Court of Perugia will have jurisdiction.

Place and date

.....

Vendor

.....

Customer

.....



TOWBARS

2023



UMBRA RIMORCHI UK LTD

Cambridge Warehouse,
Bunker 166 - Argoed -
Kinnerley, Oswestry
Shropshire - SY10 8DH



Phone : +44 208 144 0509

E-mail: trade@umbrarimorchi.co.uk

Website: www.umbrarimorchi.it

VAT Reg No GB224997276

LOCAL DEALER

v. 38B 12/04/2023



umbrarimorchi.it

